



전기·전자박스 대표 브랜드 박스코

BOXCO®

ENCLOSURES & CABLE GLANDS

Welcome to **BOXCO**® world.

I회사소개I

대 표 이 사_ 김호성
 주 생 산 품_ 전기·전자 제어기기 보호용박스, 케이스
 플라스틱 사출·주문제품개발

Company introduction

President_ Kim Ho Sung
 Main Product_ Elecatrical&Electronic control Enclosure, Case Plastic
 Injection Molding, Customized product development

I연혁 HistoryI

1996	Established electrical & electronic enclosure company	전기, 전자박스 전문회사 설립
1999	Changed to corporation	법인회사로 변경설립
2004	Relocation Head office and factory to Gwaebeop-dong, Busan Changed company name to BOXCO Inc.	괘법동 신축 사옥으로 본사 이전 주식회사 박스코로 사명 변경
2006	Obtained ISO 14001: 2004 Obtained ISO 9001: 2000	ISO 14001:2004 환경 경영 시스템 인증 획득 ISO 9001:2000 품질 경영 시스템 인증 획득
2007	Obtained TUV mark from Germany Obtained CE mark from EU Selected as Management Innovation Business Obtained K mark Selected as Prospective Small and Medium enterprise Established BOXCO Plastic Inc. factory Opened Guro branch office in Seoul(Sales)	독일 TUV 마크 획득 유럽 연합의 CE 마크 획득 경영혁신형 중소기업 선정 한국 K 마크 획득 유망중소기업 선정 박스코 플라스틱 공장 설립 구로지사(영업소) 설립
2008	Selected as Prospective Export Small and Medium enterprise Obtained UL certificate of USA	수출 유망 중소기업 선정 미국 UL 인증 획득
2009	Opened Anyang branch office in Gyeonggi-do(Sales) Obtained DIN mark from Germany Passed SGS RoHS test from Switzerland	안양지사(영업소) 설립 독일 DIN 마크 획득 스위스 SGS, RoHS 시험 통과
2011	Obtained UL508A of USA Certified Clean enterprise Certified Country of Origin Exporter Selected as one of 2011 New Exporters 300 enterprise	미국 UL508A 인증 클린 사업장 인증 원산지 인증 수출자 인증 2011 NEW EXPORTERS 300 기업 선정
2012	Selected as Leading Company of Busan Selected as Prospective Small and Medium enterprise and Family company by Industrial Bank of Korea Selected as Venture Business Selected as Innovation Business Family Company, Conclusion of Industrial Cooperation MOU with Korea Maritime and Ocean University	부산광역시 선도기업 인증 기업은행 유망중소, 패밀리 기업 선정 벤처기업 선정 기술 혁신형 중소기업 선정 한국해양대학교 산학협력, 가족회사 협약
2013	Selected as Excellent enterprise in Busan Selected as Family Company by Dongmyong University, Silla University Selected "The company where wants to work" by Kyungnam College of Information & Technology Selected Honorary branch by Busan Bank Selected BS DIAMOND GROUP by Busan Bank Selected as Company Strengthening of exportability	부산광역시 우수 기업 선정 신라대학교, 동명대학교 가족회사 협약 경남정보대학교 취업하고 싶은 기업체 인증 부산은행 명예지점 위촉 BS DIAMOND GROUP 선정 (부산은행) 수출 역량 강화 대상 기업 선정
2014	Conclusion of Industrial Cooperation MOU with Dong-A University	동아대학교 산학 협력 협약
2015	Conclusion of an agreement with Busan Future Research Center from Bukyong National University Established Enterprise Research Institute Selected as Excellent Employment Company of Busan Conclusion of Track Cooperation with Gyeongnam Provincial Geochang College Appointed company for military service Selected as Strategic Business Leading Company of Busan	부경대학교 부산미래연구센터 협약 기업부설연구소 설립 부산광역시 고용우수기업 인증 경남도립 남해대학 트랙 협약 병역지정업체 선정 부산광역시 전략산업 선도기업 선정



박스코 국내·국외 특허 및 인증현황

Patents and Certificates of Boxco

BOXCO 국내·국외 특허현황

국 외 : 상표·실용신안등록 및 출원 중

Abroad : Registration and application for overseas utility model, design and trade mark

국 내 : 상 표 등록 - 제 0612225호, 제 0645772호

실용신안 등록 - 제 0400938호, 제 0403411호, 제 0403412호, 제 20-0418448호, 제 20-0442481호

디 자 인 등록 - 제 30-0432568호, 제 30-0432568호의 01호, 제 30-0432569호, 제 30-0432569호의 01호, 제 30-0432569호의 02호, 제 30-0432569호의 03호, 제 30-0432569호의 04호, 제 30-0471878호, 제 30-0480667호, 제 30-0599655호

Korea : Trademark : 0612225, 0645772

Utility Model registration : 0400938, 0403411, 0403412, 20-0418448, 0007874

Design registration : 30-0432568, 30-0432568-01, 30-0432569, 30-0432569-01, 30-0432569-02, 30-0432569-03, 30-0432569-04, 30-0471878, 30-0480667, 30-0599655

BOXCO 국내·국외 인증현황

	<p>SBCR에서 발행한 ISO 9001 (품질경영시스템 인증) 획득 ISO 9001 approval from SGS</p>		<p>AC 600v 이하 옥내, 옥외의 전기설비에 사용하는 합성수지제박스 규격인증 KTL C067-2007 Standard Certification KTL C067-2007 for resin box used in indoor and outdoor electrical equipment below AC 600v</p>
	<p>UL (미국 보험협회 시험소)에서 UL508A 인증 획득 Obtained UL508A certificate from UL (Underwriters Laboratories) 등급 : TYPE 4X/TYPE 6X</p>		<p>한국건자재시험연구원(KICM)에서 PC난연 테스트 UL94:2003인증 Passed in combustion Resistance Test 94:2003 of Korea Institute of Construction Materials</p>
	<p>유럽공동체(유럽연합) 관장하의 범유럽 차원의 시험인증기관 EOTC에서 EN(유럽규격)에 의한 승인을 통과함. Obtained Certificate of CE by EN from EOTC (European Organization for Testing and Certification)</p>		<p>한국생활환경시험연구원(KEMTI)에서 PC/ABS, PC, PBT/PC 난연테스트 V-0 인증 Passed in combustion Resistance Test of V-0 for PC/ABS, PC, PBT/PC from Korea Environment and Merchandise Testing Institute</p>
	<p>독일 TUV 라인란드로부터 플라스틱 엔클러져 TUV마크, IP67, IK08 획득. Obtained TUV, IP67, IK08 from Germany for all products of plastic enclosures</p>		<p>스위스 제네바에 본사를 둔 인증기관으로서 SGS에서 유해물질 제한지침(ROHS) 검증을 받았음. Obtained RoHS certification from SGS, world's leading inspection in Geneva, Swiss</p>

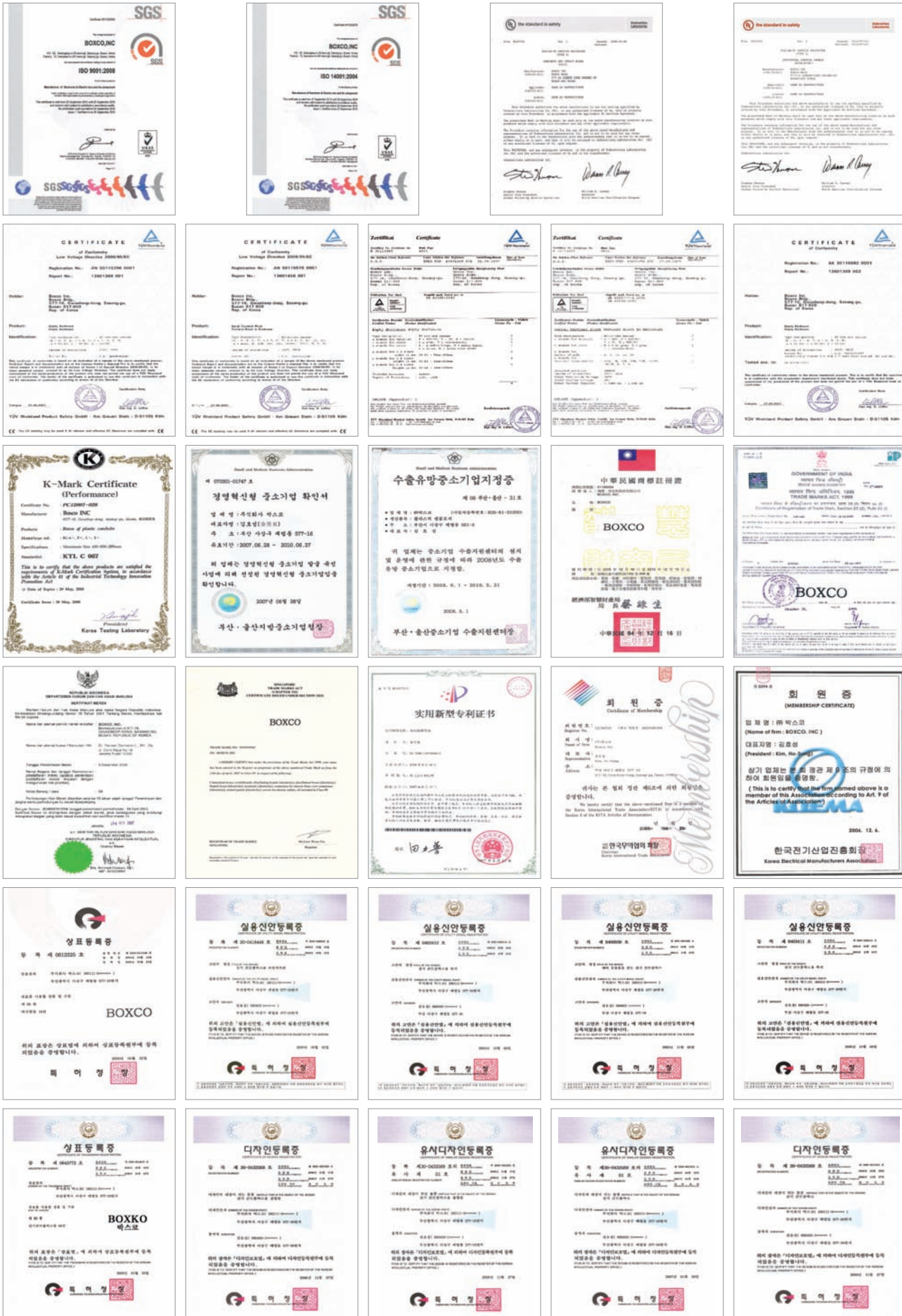

박스코 플라스틱 재료 및 보호계급

Plastic material and Protection grade of Boxco

BOXCO® 박스코 엔클로저는 국내·외에서 품질의 우수성을 인증 받은 제품입니다.
Boxco enclosures are the products with quality recognized from all over the world.

■ 박스코 플라스틱 재료의 특징 Features of plastic material of BOXCO

1. 자외선 안정제 첨가로 옥외에 장기간 사용 시에도 변색 및 탈색이 매우 적습니다.
 2. 정전기 방지 물질이 첨가된 재료를 사용하여 전기, 전자 관련기기를 보호합니다.
 3. 고충격용 재질을 사용하여 홀 가공 및 프레스 가공 시 깨짐이 없이 가공이 용이하며 외부충격에 매우 강합니다.
 4. 표준사양 외 사용지역 및 용도를 고려하여 주문하시면 선택사양 재료로 만든 최적화된 제품을 공급 받으실 수 있습니다.
1. It has few discoloration and decolorization even used for a long time at outside owing to addition of Ultraviolet Stabilizer.
 2. It protects electric/electronic instruments by using the material with addition of static electricity protecting material.
 3. It is easy to make without breakage in hole and press process and it is very strong against outside impact as it is made of high impact resistant material.
 4. We can supply optimized products which will be made of ordered material you request considering purpose and area used besides standard specification.

■ 박스코 플라스틱 재료의 재질에 대한 난연성 Combustion retardant property of BOXCO plastic material

ABS (Grey color) : 94-HB (Standard) or 94-V-0 (Options applied for terminal block)
 ABS (Grayish Blue color) : 94-5VB or 94-V-0
 PC /ABS : 94-5VA
 PC (Transparent) : 94-HB(Standard) or 94-V-0(Options applied for terminal block)
 PC (Grey) : 94-V-0

■ 박스코 플라스틱 제품의 재질에 대한 사양 Materials of BOXCO plastic products

ABS : Acrylonitrile Butadiene Styrene PC/ABS : Polycarbonate + Acrylonitrile Butadiene Styrene
 PC (Transparent) : Polycarbonate PC (Grey) : Polycarbonate or Polycarbonate + Glass Fiber
 PBT/PC : Polybutylene Terephthalate +Polycarbonate
 ※표준사양 재료는 품질 향상을 위하여 변경될 수 있습니다. Material can be changed for quality improving.

■ 모델별 사용 플라스틱 재료 Plastic materials by model

BC-AGP, AGH, AGS, AGM : Cover(ABS), Base(ABS) BC-ATP, ATH, ATS, ATM : Cover(PC), Base(ABS)
 BC-PGP, PGH, PGS, PGM : Cover(PC/ABS), Base(PC/ABS) BC-PTP, PTH, PTS, PTM : Cover(PC), Base(PC/ABS)
 BC-CGP, CGH, CGS, CGM : Cover(PC), Base(PC) BC-CTP, CTH, CTS, CTM : Cover(PC), Base(PC)



The Control Box, Terminal Box, Switch Box, Joint Box, Cable Gland.....with BOXCO.

박스코 IP·IK 보호계급 Boxco Ingress Protection Grade

※ 박스코 플라스틱 제품의 방수 방진등급 IP 66/67, 강도등급 IK 07/08 IP 66/67, IK 07/08 protection plastic enclosure
 박스코 알루미늄 제품의 방수 방진등급 IP 66/67, 강도등급 IK 09/10 IP 66/67, IK 09/10 protection aluminum enclosure

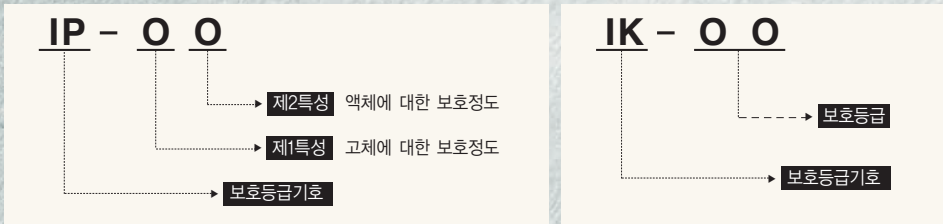

국제 전기업 협회(IEC)는 전기 기기나 보호 상자의 보호 구조에 대하여 아래와 같이 규정하고 있습니다.

IEC (International Electrotechnical Commission) defines protection structure of electric instruments or protection boxes as follows.

1항 FIRST NUMBER	고체에 대한 보호 Protection against solid	2항 SECOND NUMBER	액체에 대한 보호정도 Protection against liquids	IK code	충격에 대한 보호정도 Protection against mechanical impact
IP	테 슷 (TEST)	IP	테 슷 (TEST)	IK	테 슷 (TEST)
0	보호안됨 No protection	0	보호안됨 No protection	0	보호안됨 No protection
1	50mm이상의 고체로부터 보호됨 (손에 닿는 정도) Protected against solid objects up to 50mm, e.g. accidental touch by hands.	1	수직의 낙수물로부터 보호됨. Protection against vertically falling drops of water e.g. condensation.	01 05	충격 < 1 joule Impact < 1 joule
2	12mm이상의 고체로부터 보호됨 (손가락 크기정도) Protected against solid objects up to 12mm, e.g. fingers.	2	15° 정도 들이치는 낙하물로부터 보호됨. Protection against direct sprays of water up to 15° from the vertical.	06	충격 = 1 joule Impact = 1 joule
3	2.5mm 이상의 고체로부터 보호됨 (연장, 전선크기) Protected against solid objects over 2.5mm (tools and wires).	3	60° 까지의 스프레이로부터 보호됨. Protection against direct sprays of water up to 60° from the vertical.	07	충격 = 2 joule Impact = 2 joule
4	1mm이상의 고체로부터 보호됨(가는 연장, 가는 전선) Protected against solid objects over 1mm (tools, wires and small wire).	4	모든 방향의 스프레이로부터 보호됨. Protection against water sprays from all directions or limited ingress permitted.	08	충격 = 5 joule Impact = 5 joule
5	먼지로부터 보호됨. Protected against dust limited ingress (no harmful deposit).	5	모든 방향의 낮은 압력으로 분사되는 물로부터 보호됨. Protected against low pressure jets of water from all directions or limited ingress.	09	충격 = 10 joule Impact = 10 joule
6	먼지로부터 완벽하게 보호됨. Totally protected against dust.	6	모든 방향의 높은 압력으로 분사되는 물로부터 보호됨. Protected against low pressure jets of water, e.g. for use on ship decks—limited ingress permitted.	10	충격 = 20 joule Impact = 20 joule
		7	15cm~1m까지 30분동안 침수 되어도 보호됨. Protected against the effect of immersion between 15cm and 1m		
		8	장기간 침수되어 수압을 받아도 보호됨. Protected against long periods of immersion under pressure.		

박스코 플라스틱 엔클로저의 특징

Characteristics of BOXCO plastic enclosure

<p>P series-draw latch, integrated hinge</p> <p>매미고리의 중요 부분을 스테인레스로, 힌지를 플라스틱 일체형으로 성형하여 매우 견고하고 커버 분리가 용이하여 타공이나 인쇄시 편리합니다. It is very strong, easy to remove cover and convenient to make hole or print as main parts of draw latch are made of stainless steel and hinge is made of plastic in integrated type.</p>		<p>Bracket attachment part</p> <p>사출성형 시 황동 인쇼트를 삽입하여 제조하였으므로 BOX를 견고하게 고정할 수 있습니다. It helps to fix the box tightly as brass insert is inserted in injection molding.</p>	
<p>P series - roof function</p> <p>베이스에 일체형으로 돌출되어 있으며 평소 물 등의 침투를 방지하며 커버 개폐시는 상부에 쌓인 먼지의 침투를 막아 줍니다. It is protruded at base. It protects penetration of water at ordinary times and penetration of dust when opening/closing the cover.</p>		<p>SUS bracket</p> <p>BOX를 벽면에 부착시킬 때 브라켓을 이용하여 취부할 수 있습니다. 모델 No : B60, B50, B40 You can use this bracket to fix the box to the wall.</p>	
<p>H series - SUS Latch</p> <p>진동 등에 의한 풀림 방지용 이중 잠금 장치가 첨가된 매미고리입니다. 모델 No : M75, M65, M55 It prevents loosening by vibration etc. It has double lock system.</p>		<p>Back Panel connecting part</p> <p>사출성형 시 황동인쇼트를 삽입하여 제조하였으므로 무거운 부품을 장착한 속판을 견고하게 고정할 수 있습니다. Inner panel equipped with heavy parts can be fixed tightly as brass insert is inserted in injection molding.</p>	
<p>H series - SUS Hinge</p> <p>BOX규격별로 힌지의 크기가 다양하게 적용되어 내구성을 보장합니다. 모델 No : H75, H65, H55 To ensure durability SUS hinge has various application to each size of enclosure.</p>		<p>Plastic Back Panel</p> <p>타공이 쉽고 절연성이 우수하며 ABS 재질로 매우 견고하게 만들었습니다. It is easy to make hole and it has excellent insulation property. It is made to be strong with ABS material.</p>	
<p>H series - Rubber washer</p> <p>힌지, 매미고리나 기타 부품 장착 시 방수, 방진용으로 장착되고 있습니다. It is used for water proofing or dust proofing in installation of hinge, draw latch or other parts.</p>		<p>Key ring</p> <p>자물쇠를 걸 수 있는 고리입니다. 모델 No : K40 It can hang a lock on enclosure.</p>	
<p>S series - Cover bolt connecting part</p> <p>사출성형 시 나사산을 베이스에 일체형으로 성형하여 견고합니다. It is strong as screw thread was made in injection molding.</p>		<p>Lock</p> <p>내장형 잠금장치입니다. 모델 No : SK Embedded lock</p>	
<p>S series - Slide marking</p> <p>힌지, 매미고리 장착 시 소형 드릴만으로 정확하게 타공할 수 있도록 제작되었습니다. It was made to make hold only with small drill in installation of hinge or draw latch.</p>		<p>Plastic lock</p> <p>방수용 잠금장치입니다. 모델 No : PK Water proof lock</p>	
<p>S series - General marking</p> <p>힌지, 매미고리 장착 시 마킹부위에 정확히 타공하므로 밀폐력이 우수합니다. It has excellent airtightness due to accurate puncture on marking part in installation of hinge or draw latch</p>		<p>P series - Integral lock</p> <p>P type 전용 잠금장치 일체형 매미고리입니다. It is integrated with draw and key lock for P type</p>	
<p>M series - Screw type</p> <p>멤브레인키보드 부착을 고려하여 커버 표면을 약간 낮추어 설계하였습니다. It is designed to have lower surface of the cover considering attachment of membrane keyboard.</p>		<p>Gasket</p> <p>가스켓용액을 초정밀 CNC 로봇기계로 토출하여 주입하므로 방수, 방진에 탁월합니다. It has excellent water and dust proofing performance as it injects gasket solution with super precise CNC robot machine.</p>	

박스코 제품 규격표

BOXCO Size



BOXCO 제품 모델 선정법 BOXCO product model name

BC-AGP-203015

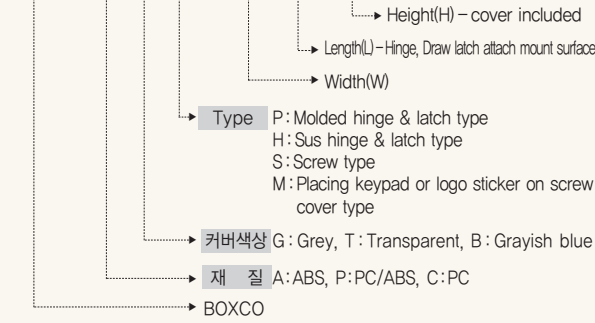

Size table of plastic enclosure



P Series

MODEL	Width×Length×Height
BC-□□P-091207	90×120×70
BC-□□P-091208	90×120×85
BC-□□P-101507	100×150×70
BC-□□P-101508	100×150×85
BC-□□P-112107	110×210×75
BC-□□P-112110	110×210×100
BC-□□P-112607	110×260×75
BC-□□P-112610	110×260×100
BC-□□P-131508	135×155×85
BC-□□P-131808	135×185×85
BC-□□P-131810	135×185×100
BC-□□P-151509	150×150×90
BC-□□P-151512	150×150×120
BC-□□P-162110	160×210×100
BC-□□P-162113	160×210×130
BC-□□P-162610	160×260×100
BC-□□P-162613	160×260×130
BC-□□P-172211	170×220×110
BC-□□P-172711	170×270×110
BC-□□P-212110	210×210×100
BC-□□P-212113	210×210×130
BC-□□P-192810	190×280×100
BC-□□P-192814	190×280×140
BC-□□P-203013	200×300×130
BC-□□P-203015	200×300×150
BC-□□P-203018	200×300×180
BC-□□P-253515	250×350×150
BC-□□P-253518	250×350×180
BC-□□P-282813	280×280×130
BC-□□P-283813	280×380×130
BC-□□P-303015	300×300×150
BC-□□P-303018	300×300×180
BC-□□P-304012	300×400×120
BC-□□P-304015	300×400×150
BC-□□P-304018	300×400×180
BC-□□P-353515	350×350×150
BC-□□P-353518	350×350×180

P Series

MODEL	Width×Length×Height
BC-□□P-354512	350×450×120
BC-□□P-354516	350×450×160
BC-□□P-354520	350×450×200
BC-□□P-405016	400×500×160
BC-□□P-405020	400×500×200
BC-□□P-406018	400×600×180
BC-□□P-406023	400×600×230
BC-□□P-506018	530×630×185
BC-□□P-506025	530×630×255
BC-□□P-507018	530×730×185
BC-□□P-507025	530×730×255
BC-□□P-608018	630×830×185
BC-□□P-608028	630×830×285



H Series - Medium and large size

MODEL	Width×Length×Height
BC-□□H-222712	225×275×120
BC-□□H-272212	275×225×120
BC-□□H-203015	200×300×150
BC-□□H-302015	300×200×150
BC-□□H-203018	200×300×180
BC-□□H-302018	300×200×180
BC-□□H-253515	250×350×150
BC-□□H-352515	350×250×150
BC-□□H-304015	300×400×150
BC-□□H-403015	400×300×150
BC-□□H-304018	300×400×180
BC-□□H-403018	400×300×180
BC-□□H-354516	350×450×160
BC-□□H-453516	450×350×160
BC-□□H-354520	350×450×200
BC-□□H-453520	450×350×200
BC-□□H-405020	400×500×200
BC-□□H-504020	500×400×200
BC-□□H-406023	400×600×230
BC-□□H-604023	600×400×230



H Series - Medium size

MODEL	Width×Length×Height
BC-□□H-191913	190×190×130
BC-□□H-192813	190×280×130

박스코 제품 규격표

BOXCO Size

H Series - Medium size

MODEL	Width×Length×Height
BC-□□H-281913	280×190×130
BC-□□H-192818	190×280×180
BC-□□H-281918	280×190×180
BC-□□H-193813	190×380×130
BC-□□H-381913	380×190×130
BC-□□H-193818	190×380×180
BC-□□H-381918	380×190×180
BC-□□H-282813	280×280×130
BC-□□H-283413	280×340×130
BC-□□H-342813	340×280×130
BC-□□H-283813	280×380×130
BC-□□H-382813	380×280×130
BC-□□H-283818	280×380×180
BC-□□H-382818	380×280×180
BC-□□H-285613	280×560×130
BC-□□H-562813	560×280×130
BC-□□H-334318	330×430×180
BC-□□H-433318	430×330×180
BC-□□H-385618	380×560×180
BC-□□H-563818	560×380×180



H Series - Small size

MODEL	Width×Length×Height
BC-□□H-081107	80×110×70
BC-□□H-110807	110×80×70
BC-□□H-081108	80×110×85
BC-□□H-110808	110×80×85
NEW BC-□□H-081110	80×110×100
NEW BC-□□H-110810	110×80×100
BC-□□H-081307	80×130×70
BC-□□H-130807	130×80×70
BC-□□H-081308	80×130×85
BC-□□H-130808	130×80×85
BC-□□H-081807	80×180×70
BC-□□H-180807	180×80×70
BC-□□H-081808	80×180×85
BC-□□H-180808	180×80×85
BC-□□H-082507	80×250×70
BC-□□H-250807	250×80×70
BC-□□H-082508	80×250×85
BC-□□H-250808	250×80×85
BC-□□H-101007	100×100×75
BC-□□H-101010	100×100×100
BC-□□H-121207	125×125×75
BC-□□H-121210	125×125×100
BC-□□H-121707	125×175×75
BC-□□H-171207	175×125×75
BC-□□H-121710	125×175×100
BC-□□H-171210	175×125×100
BC-□□H-141709	140×170×95
BC-□□H-171409	170×140×95
BC-□□H-142309	140×230×95
BC-□□H-231409	230×140×95
BC-□□H-151507	150×150×75
BC-□□H-151510	150×150×100

H Series - Small size

MODEL	Width×Length×Height
BC-□□H-152007	150×200×75
BC-□□H-201507	200×150×75
BC-□□H-152010	150×200×100
BC-□□H-201510	200×150×100
BC-□□H-152013	150×200×130
BC-□□H-201513	200×150×130
BC-□□H-152016	150×200×160
BC-□□H-201516	200×150×160
BC-□□H-152510	150×250×100
BC-□□H-251510	250×150×100
BC-□□H-152513	150×250×130
BC-□□H-251513	250×150×130
BC-□□H-202010	200×200×100
BC-□□H-202013	200×200×130
BC-□□H-202016	200×200×160
NEW BC-□□H-202019	200×200×190
NEW BC-□□H-212310	210×230×100
NEW BC-□□H-232110	230×210×100



S Series - Medium size

MODEL	Width×Length×Height
BC-□□S-191913	190×190×130
BC-□□S-192813	190×280×130
BC-□□S-192818	190×280×180
BC-□□S-193813	190×380×130
BC-□□S-193818	190×380×180
BC-□□S-282813	280×280×130
BC-□□S-283413	280×340×130
BC-□□S-283813	280×380×130
BC-□□S-283818	280×380×180
BC-□□S-285613	280×560×130
BC-□□S-334318	330×430×180
BC-□□S-385618	380×560×180



S Series - Small size

MODEL	Width×Length×Height
BC-□□S-050604	50×65×45
BC-□□S-050605	50×65×55
BC-□□S-060905	65×95×55
BC-□□S-071005	75×105×55

S Series - Small size

MODEL	Width×Length×Height
BC-□□S-080806	80×80×60
BC-□□S-081104	80×110×45
BC-□□S-081107	80×110×70
BC-□□S-081108	80×110×85
NEW BC-□□S-081110	80×110×100
BC-□□S-081307	80×130×70
BC-□□S-081308	80×130×85
BC-□□S-081605	80×160×55
BC-□□S-081608	80×160×85
BC-□□S-081807	80×180×70
BC-□□S-081808	80×180×85
BC-□□S-082507	80×250×70
BC-□□S-082508	80×250×85
BC-□□S-101007	100×100×75
BC-□□S-101010	100×100×100
BC-□□S-101807	100×185×70
BC-□□S-102007	100×200×70
BC-□□S-102307	100×230×70
BC-□□S-121207	125×125×75
BC-□□S-121210	125×125×100
BC-□□S-121707	125×175×75
BC-□□S-121710	125×175×100
BC-□□S-141709	140×170×95
BC-□□S-142309	140×230×95
BC-□□S-151507	150×150×75
BC-□□S-151510	150×150×100
NEW BC-□□S-152004	150×200×45
BC-□□S-152007	150×200×75
BC-□□S-152010	150×200×100
BC-□□S-152013	150×200×130
BC-□□S-152016	150×200×160
BC-□□S-152510	150×250×100
BC-□□S-152513	150×250×130
BC-□□S-161607	160×160×70
BC-□□S-202010	200×200×100
BC-□□S-202013	200×200×130
BC-□□S-202016	200×200×160
NEW BC-□□S-202019	200×200×190
NEW BC-□□S-212310	210×230×100



M Series

MODEL	Width×Length×Height
BC-□□M-081303	80×130×35
BC-□□M-081306	80×130×60
BC-□□M-081307	80×130×75
BC-□□M-081308	80×130×85
BC-□□M-081310	80×130×100
BC-□□M-081312	80×130×125
BC-□□M-131303	130×130×35
BC-□□M-131306	130×130×60
BC-□□M-131803	130×180×35
BC-□□M-131806	130×180×60
BC-□□M-151806	150×180×60
BC-□□M-181806	180×180×60
BC-□□M-181807	180×180×75
BC-□□M-181810	180×180×100
BC-□□M-181812	180×180×125
BC-□□M-182507	180×255×75
BC-□□M-182510	180×255×100
BC-□□M-182512	180×255×125

Knock-out Box



KNOCK-OUT BOX

MODEL	Width×Length×Height
BC-□□S-081107	80×110×70
BC-□□S-081108	80×110×85
BC-□□S-081307	80×130×70
BC-□□S-081308	80×130×85
BC-□□S-081807	80×180×70
BC-□□S-081808	80×180×85
BC-□□S-082507	80×250×70
BC-□□S-082508	80×250×85
BC-□□S-121707	125×175×75
BC-□□S-121710	125×175×100

Push Button Box



BOXCO Push Button Plastic Box

MODEL	HOLE
BC-□GS-08110□-□□01	1-Hole
BC-□GS-08130□-□□02	2-Hole
BC-□GS-08180□-□□03	3-Hole
BC-□GS-08250□-□□04	4-Hole

BOXCO Push Button Aluminium Box

MODEL	HOLE
BC-AL-08080□-□□01	1-Hole
BC-AL-08130□-□□02	2-Hole
BC-AL-08180□-□□03	3-Hole
BC-AL-08250□-□□04	4-Hole



Terminal Block Box

MODEL	Width×Length×Height
BC-□□-4P	55×91×43
BC-□□-4PH	50×82×43
BC-□□-4P16H	50×82×43
BC-□□-4P1618H	50×82×43
BC-□□-4P18H	50×82×43
BC-□□-4P1821H	50×82×43
BC-□□-4P21H	50×82×43
BC-□□-4P-T	65×74×43
BC-□□-4P-PG	65×74×43
BC-□□-6P	75×91×43
BC-□□-6PH	55×91×43
BC-□□-6P18H	55×91×43

박스코 제품 규격표

BOXCO Size

Terminal Block Box

MODEL	Width×Length×Height
BC-□□-6P1821H	55 × 91 × 43
BC-□□-6P21H	55 × 91 × 43
BC-□□-6P-T	75 × 91 × 43
BC-□□-6P-PG	75 × 91 × 43
BC-□□-10P	75 × 125 × 43
BC-□□-10P-T	75 × 125 × 43
BC-□□-15P	100 × 185 × 70
BC-□□-15P-T	100 × 185 × 70
BC-□□-20P	100 × 230 × 70
BC-□□-20P-T	100 × 230 × 70
BC-□□-20P-A	160 × 160 × 70
BC-□□-20P-2	160 × 160 × 70

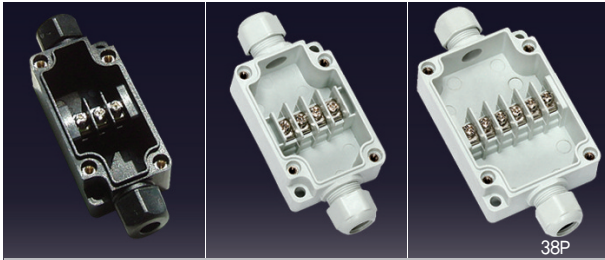

PBT Serie

MODEL	Width×Length×Height
BC-PB□-3P	33 × 65 × 24 × 9.2
BC-PB□-4P	40 × 60 × 24 × 9.2
BC-PB□-6P	50 × 70 × 24 × 9.2

Aluminium box



Aluminium Box

MODEL	Width×Length×Height
BC-AL-050503	45 × 50 × 32
BC-AL-060603	64 × 58 × 34
BC-AL-060605	64 × 58 × 46
BC-AL-061003	64 × 98 × 34
BC-AL-061005	64 × 98 × 46
BC-AL-061503	64 × 150 × 34
BC-AL-061505	64 × 150 × 46
BC-AL-080806	80 × 75 × 57
BC-AL-080807	80 × 75 × 70
BC-AL-081306	80 × 125 × 57
BC-AL-081307	80 × 125 × 70
BC-AL-081806	80 × 175 × 57
BC-AL-081807	80 × 175 × 70
BC-AL-082506	80 × 250 × 57
BC-AL-082507	80 × 250 × 70
BC-AL-101008	100 × 100 × 81
BC-AL-101608	100 × 160 × 81
BC-AL-121208	120 × 122 × 81
BC-AL-122208	120 × 220 × 81
BC-AL-122209	120 × 220 × 91
BC-AL-123608	120 × 360 × 81
BC-AL-151309	150 × 132 × 90
BC-AL-161609	160 × 160 × 91
BC-AL-162110	160 × 210 × 100
BC-AL-162609	160 × 260 × 91
BC-AL-163609	160 × 360 × 91
BC-AL-181810	180 × 180 × 101
BC-AL-232011	230 × 200 × 111
BC-AL-232018	230 × 200 × 180
BC-AL-232811	230 × 280 × 111
BC-AL-233311	230 × 330 × 111
BC-AL-314011	313 × 404 × 111
BC-AL-314018	313 × 404 × 181



40P~44P

Aluminium Terminal Block Box

MODEL	Width×Length×Height
BC-AL-5P-T	80 × 75 × 57
BC-AL-6P	80 × 75 × 57
BC-AL-9P	100 × 100 × 80
BC-AL-10P-T	80 × 125 × 57
BC-AL-15P-T	100 × 160 × 80
BC-AL-15P	100 × 160 × 80
BC-AL-20P-T	120 × 220 × 80
BC-AL-20P	120 × 220 × 80
BC-AL-20P-AS	150 × 130 × 90
BC-AL-20P-A	160 × 160 × 90
BC-AL-20P-2	160 × 160 × 90
BC-AL-25P-T	160 × 260 × 90
BC-AL-30P-AS	120 × 220 × 80
BC-AL-30P-A	180 × 180 × 100
BC-AL-30P-2	230 × 220 × 110
BC-AL-40P-A	160 × 260 × 90
BC-AL-40P-2	160 × 260 × 90
BC-AL-45P-3	230 × 220 × 110
BC-AL-50P-A	160 × 260 × 90



47P

Dual Door Enclosure

MODEL	Width×Length×Height
BC-□□P-203013	200 × 300 × 130
BC-□□P-203015	200 × 300 × 150
BC-□□P-203018	200 × 300 × 180
BC-□□P-253515	250 × 350 × 150
BC-□□P-253518	250 × 350 × 180
BC-□□P-282813	280 × 280 × 130
BC-□□P-283813	280 × 380 × 130
BC-□□P-303015	300 × 300 × 150
BC-□□P-303018	300 × 300 × 180
BC-□□P-304015	300 × 400 × 150
BC-□□P-304018	300 × 400 × 180
BC-□□P-354516	350 × 450 × 160
BC-□□P-354520	350 × 450 × 200
BC-□□P-405016	400 × 500 × 160
BC-□□H-405020	400 × 500 × 200
BC-□□P-405020	400 × 500 × 200
BC-□□H-406018	400 × 600 × 180
BC-□□P-406018	400 × 600 × 180
BC-□□P-406023	400 × 600 × 230
BC-□□P-506018	530 × 630 × 185
BC-□□P-506025	530 × 630 × 255



48P

All-In-One-Dual door enclosure

MODEL	Width×Length×Height
□GD-253516	250×350×160
□GD-253519	250×350×190
□GD-354513	350×450×130
□GD-354517	350×450×170
□GD-354521	350×450×210



49P

Boxco aluminium housing for inserting card

MODEL	Width×Length×Height
BC-ALC-111609	111.5×166×91.5
BC-ALC-172011	173×206×113

Size table of cable gland



51P~57P

BC-PG

MODEL	케이블굵기(φmm)	MODEL	케이블굵기(φmm)
BC-PG7-G	3 ~ 6.5	BC-PG25-G	16 ~ 21
BC-PG9-G	4 ~ 8	BC-PG29-G	18 ~ 25
BC-PG11-G	5 ~ 10	BC-PG36-G	22 ~ 32
BC-PG13.5-G	6 ~ 12	BC-PG42-G	32 ~ 38
BC-PG16-G	10 ~ 14	BC-PG48-G	37 ~ 44
BC-PG19-G	12 ~ 16	BC-PG63-G	42 ~ 50
BC-PG21-G	13 ~ 18		

BC-PG-L

MODEL	케이블굵기(φmm)	MODEL	케이블굵기(φmm)
BC-PG7L-G	3 ~ 6.5	BC-PG16L-G	10 ~ 14
BC-PG9L-G	4 ~ 8	BC-PG21L-G	13 ~ 18
BC-PG11L-G	5 ~ 10	BC-PG29L-G	18 ~ 25
BC-PG13.5L-G	6 ~ 12		

BC-BP-PG

MODEL	케이블굵기(φmm)	MODEL	케이블굵기(φmm)
BC-BP-PG7-G	3 ~ 6.5	BC-BP-PG13.5-G	6 ~ 12
BC-BP-PG9-G	4 ~ 8	BC-BP-PG16-G	10 ~ 14
BC-BP-PG11-G	5 ~ 10	BC-BP-PG21-G	13 ~ 18

BC-MPG

MODEL	케이블굵기(φmm)	MODEL	케이블굵기(φmm)
BC-MPG7	3 ~ 6.5	BC-MPG25	16 ~ 22
BC-MPG9	4 ~ 8	BC-MPG29	18 ~ 25
BC-MPG11	5 ~ 10	BC-MPG36	22 ~ 32
BC-MPG13.5	6 ~ 12	BC-MPG42	32 ~ 38
BC-MPG16	10 ~ 14	BC-MPG48	37 ~ 44
BC-MPG19	12 ~ 15	BC-MPG63	42 ~ 52
BC-MPG21	13 ~ 18		

BC-MPG-L

MODEL	케이블굵기(φmm)	MODEL	케이블굵기(φmm)
BC-MPG7L	3 ~ 6.5	BC-MPG21L	13 ~ 18
BC-MPG9L	4 ~ 8	BC-MPG25L	16 ~ 22
BC-MPG11L	5 ~ 10	BC-MPG29L	18 ~ 25
BC-MPG13.5L	6 ~ 12	BC-MPG36L	22 ~ 32
BC-MPG16L	10 ~ 14	BC-MPG42L	32 ~ 38
BC-MPG19L	12 ~ 15	BC-MPG48L	37 ~ 44

BC-PKM-P

MODEL	케이블굵기(φmm)	MODEL	케이블굵기(φmm)
BC-PKM-P7	6 ~ 8	BC-PKM-P11	10 ~ 12
BC-PKM-P9	8 ~ 10	BC-PKM-P13	12 ~ 14

BC-HSK-EX-P

MODEL	케이블굵기(φmm)	MODEL	케이블굵기(φmm)
BC-HSK-EX-P7	3 ~ 6.5	BC-HSK-EX-P21	13 ~ 18
BC-HSK-EX-P9	4 ~ 8	BC-HSK-EX-P29	18 ~ 25
BC-HSK-EX-P11	5 ~ 10	BC-HSK-EX-P36	22 ~ 32
BC-HSK-EX-P13	6 ~ 12	BC-HSK-EX-P42	30 ~ 38
BC-HSK-EX-P16	8 ~ 14	BC-HSK-EX-P48	37 ~ 44

BC-HSM-EX-P

MODEL	케이블굵기(φmm)	MODEL	케이블굵기(φmm)
BC-HSM-EX-P7	3 ~ 6.5	BC-HSM-EX-P21	13 ~ 18
BC-HSM-EX-P9	4 ~ 8	BC-HSM-EX-P29	18 ~ 25
BC-HSM-EX-P11	5 ~ 10	BC-HSM-EX-P36	22 ~ 32
BC-HSM-EX-P13	6 ~ 12	BC-HSM-EX-P42	30 ~ 38
BC-HSM-EX-P16	8 ~ 14	BC-HSM-EX-P48	37 ~ 44

BC-RG-PG

MODEL	케이블굵기(φmm)	MODEL	케이블굵기(φmm)
BC-RG-PG7	3 ~ 5	BC-RG-PG21	14 ~ 20
BC-RG-PG9	5 ~ 7	BC-RG-PG29	20 ~ 26
BC-RG-PG11	7 ~ 10	BC-RG-PG36	26 ~ 35
BC-RG-PG16	10 ~ 14		

BC-M

MODEL	케이블굵기(φmm)	MODEL	케이블굵기(φmm)
BC-M12-G	3 ~ 6.5	BC-M27-G	13 ~ 18
BC-M16-G	4 ~ 8	BC-M30-G	16 ~ 21
BC-M18-G	5 ~ 10	BC-M32-G	18 ~ 25
BC-M20-G	6 ~ 12	BC-M36-G	18 ~ 25
BC-M22-G	10 ~ 14	BC-M40-G	22 ~ 32
BC-M24-G	12 ~ 16	BC-M50-G	32 ~ 38
BC-M25-G	12 ~ 16	BC-M63-G	37 ~ 44

BC-M-L

MODEL	케이블굵기(φmm)	MODEL	케이블굵기(φmm)
BC-M12L	3 ~ 6.5	BC-M22L	10 ~ 14
BC-M16L	4 ~ 8	BC-M25L	12 ~ 16
BC-M18L	5 ~ 10	BC-M32L	18 ~ 25
BC-M20L	6 ~ 12		

BC-BP-M

MODEL	케이블굵기(φmm)	MODEL	케이블굵기(φmm)
BC-BP-M12-G	3 ~ 6.5	BC-BP-M20-G	6 ~ 12
BC-BP-M16-G	4 ~ 8	BC-BP-M22-G	10 ~ 14
BC-BP-M18-G	5 ~ 10	BC-BP-M25-G	13 ~ 18

BC-MM

MODEL	케이블굵기(φmm)	MODEL	케이블굵기(φmm)
BC-MM12	3 ~ 6.5	BC-MM27	13 ~ 18
BC-MM16	4 ~ 8	BC-MM30	16 ~ 22
BC-MM18	5 ~ 10	BC-MM32	16 ~ 22
BC-MM20	6 ~ 12	BC-MM36	18 ~ 25
BC-MM22	10 ~ 14	BC-MM40	22 ~ 32
BC-MM24	12 ~ 15	BC-MM50	32 ~ 38
BC-MM25	13 ~ 18	BC-MM63	37 ~ 44

BC-MM-L

MODEL	케이블굵기(φmm)	MODEL	케이블굵기(φmm)
BC-MM12L	3 ~ 6.5	BC-MM27L	13 ~ 18
BC-MM16L	4 ~ 8	BC-MM30L	16 ~ 22
BC-MM18L	5 ~ 10	BC-MM32L	16 ~ 22
BC-MM20L	6 ~ 12	BC-MM36L	18 ~ 25
BC-MM22L	10 ~ 14	BC-MM40L	22 ~ 32
BC-MM24L	12 ~ 15	BC-MM50L	32 ~ 38
BC-MM25L	13 ~ 18	BC-MM63L	37 ~ 44

※ 규격 외의 제품은 주문제작 가능합니다. Custom made is possible for non-standardized products

P시리즈 (플라스틱 일체형 힌지 타입)

P Series



*속판 규격은 플라스틱 속판 기준이며, ()안은 철 속판 규격임.
The dimension of mounting plate is based on the plastic mounting plate and the dimension of around bracket is steel mounting plate

Dimension (허용오차 ±1mm)

BASE

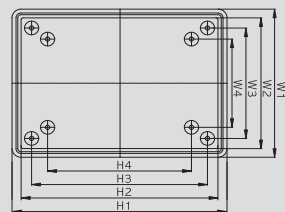

COVER

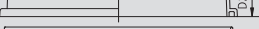

BASE



COVER + BASE



MOUNTING PLATE (속판)

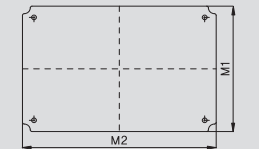

Size	Division				H1	H2	H3	H4	D1	D2	D3
	W1	W2	W3	W4							
90×120×70	90	69	50	0	128.4	99	80	69	50	20	51.5
90×120×85	90	69	50	0	128.4	99	80	69	65	20	66.5
100×150×70	100	77.7	60	0	158.4	127.7	110	99	50	20	51.5
100×150×85	100	77.7	60	0	158.4	127.7	110	99	65	20	66.5
110×210×75	110	87.7	70	0	218.4	187.7	170	158	55	20	56.5
110×210×100	110	87.7	70	0	218.4	187.7	170	158	80	20	81.5
110×260×75	110	87.7	70	0	268	238.7	219	208	55	20	56.5
110×260×100	110	87.7	70	0	268	238.7	219	208	80	20	81.5
135×155×85	135	112.5	94.5	0	163.2	132.5	114.5	110	65	20	67.5
135×185×85	135	112.5	95	0	193.4	163	145	140	65	20	67.5
135×185×100	135	112.5	95	0	193.4	163	145	140	80	20	82.5
150×150×90	150	128	116.5	0	158.5	128	116.5	110	70	20	71.5
150×150×120	150	128	116.5	0	158.5	128	116.5	110	100	20	101.5
160×210×100	160	137	120	0	218.4	188.5	170	160	75	25	81.5
160×210×130	160	137	120	0	218.4	188.5	170	160	105	25	111.5
160×260×100	160	137	120	0	268.4	238.7	220	210	75	25	85.5
160×260×130	160	137	120	0	268.4	238.7	220	210	105	25	111.5
170×220×110	170	148	132	0	228.4	198	182	160	80	30	93
170×270×110	170	148	132	0	278.4	247	232	210	80	30	93
210×210×100	210	187	170	120	218.4	187	170	150	75	25	81.5
210×210×130	210	187	170	120	218.4	187	170	150	105	25	111.5
190×280×100	190	167	147.5	120	288.4	257	238	210	70	30	108.5
190×280×140	190	167	147.5	120	288.4	257	238	210	110	30	128.5
200×300×130	200	178	152	129	308.4	278	252	226	100	30	108
200×300×150	200	178	152	129	308.4	278	252	226	120	30	128.5
200×300×180	200	178	152	129	308.4	278	252	226	150	30	158.5
250×350×150	250	227	205	180	358.4	327	305	269	120	30	130
250×350×180	250	227	205	180	358.4	327	305	269	150	30	160
280×280×130	280	257	238	210	288.4	257	238	210	100	30	108
280×380×130	280	257	238	210	388.4	357	338	310	100	30	108
300×300×150	300	278	252	230	308.4	278	252	219	120	30	131.5
300×300×180	300	278	252	230	308.4	278	252	219	150	30	161.5
300×400×120	300	275.5	252	228	408.4	370.5	352	325	90	30	98.5
300×400×150	300	275.5	252	228	408.4	370.5	352	325	120	30	128.5
300×400×180	300	275.5	252	228	408.4	370.5	352	325	150	30	158.5
350×350×150	350	327	302	270	358.4	327	302	270	120	30	132
350×350×180	350	327	302	270	358.4	327	302	270	150	30	162
350×450×120	350	325.4	300	274	457.4	425	400	365	90	30	98
350×450×160	350	325.4	300	274	457.4	425	400	365	130	30	138
350×450×200	350	325.4	300	274	457.4	425	400	365	170	30	178
400×500×160	400	370.5	352	328	511.4	470.5	452	428	130	30	137
400×500×200	400	370.5	352	328	511.4	470.5	452	428	170	30	178
400×600×180	401	370.5	352	328	611.4	560	552.5	525	150	30	158
400×600×230	401	370.5	352	328	611.4	560	552.5	525	200	30	208
530×630×185	530	485	462	426	641.4	585	562	526	150	35	163
530×630×255	530	485	462	426	641.4	585	562	526	220	35	233
530×730×185	530	485	462	426	741.4	685	662	626	150	35	163
530×730×255	530	485	462	426	741.4	685	662	626	220	35	233
630×830×185	630	585	562	526	841.4	785	762	726	150	35	163
630×830×285	630	585	562	526	841.4	785	762	726	250	35	253

방수,방진 보호등급	IP 66/67
충격 테스트	IK 07/08
온도영역	ABS : -40~+85 PC : -40~+120
난연성	ABS : 94-HB PC:94-V-0~5VA PC : 94-HB, 94-V-0~5VA

제품특징 Product characteristics

1. 베이스 상·하부에 지붕(Roof)이 돌출되어 있어 비나 먼지 등의 침투를 이중으로 완벽하게 차단하는 디자인으로 제작되었습니다.
 2. 커버와 베이스의 분리가 용이하여 가공 및 인쇄작업시 사용자가 쉽게 탈부착 가능토록 제작 하였습니다.
 3. 제품에 힌지를 일체형으로 성형하였으며, 힌지 연결핀과 매미고리 중요부위를 스테인레스로 제작하여 매우 견고하며 부식이 거의 없습니다.
1. It is designed to prevent the penetration of rain or dust perfectly double as roof is protruded from top and bottom of the base.
 2. It is easy to separate cover and base so that user can attach or detach them for processing and printing.
 3. Insert hinge into the product and hinge connecting pin and important parts of draw latch are made of stainless steel so that it is very strong and corrosion resistant.



모델규격 Model and size

Model and size (cover included)		제품모델 Product model		속판모델 Plate Model		속판규격 Plate Size	
Width×Length×Height (mm)	Width×Length×Height (inch)	ABS	PC	Steel mounting plate 1.6mm	Plastic mounting plate 3~4.5mm	M1	M2
		G:Grey Cover,T:Transparent Cover 	G:Grey Cover,T:Transparent Cover 				
90×120×70	3.54×4.72×2.76	BC-A□P-091207	BC-C□P-091207	0912 S	0912 P	65	95
90×120×85	3.54×4.72×3.35	BC-A□P-091208	BC-C□P-091208	0912 S	0912 P	65	95
100×150×70	3.94×5.91×2.76	BC-A□P-101507	BC-C□P-101507	1015 S	1015 P	65	115
100×150×85	3.94×5.91×3.35	BC-A□P-101508	BC-C□P-101508	1015 S	1015 P	65	115
110×210×75	4.33×8.27×2.95	BC-A□P-112107	BC-C□P-112107	1121 S	1121 P	88	189
110×210×100	4.33×8.27×3.94	BC-A□P-112110	BC-C□P-112110	1121 S	1121 P	88	189
110×260×75	4.33×10.24×2.95	BC-A□P-112607	BC-C□P-112607	1126 S	1126 P	85	232
110×260×100	4.33×10.24×3.94	BC-A□P-112610	BC-C□P-112610	1126 S	1126 P	85	232
135×155×85	5.12×5.91×3.35	BC-A□P-131508	BC-C□P-131508	1315 S	1315 P	101	126
135×185×85	5.12×7.09×3.35	BC-A□P-131808	BC-C□P-131808	1318 S	1318 P	113	161
135×185×100	5.12×7.09×3.94	BC-A□P-131810	BC-C□P-131810	1318 S	1318 P	113	161
150×150×90	5.91×5.91×3.54	BC-A□P-151509	BC-C□P-151509	1515 S	1515 P	123	123
150×150×120	5.91×5.91×4.72	BC-A□P-151512	BC-C□P-151512	1515 S	1515 P	123	123
160×210×100	6.30×8.27×3.94	BC-A□P-162110	BC-C□P-162110	1621 S	1621 P	129	179
160×210×130	6.30×8.27×5.12	BC-A□P-162113	BC-C□P-162113	1621 S	1621 P	129	179
160×260×100	6.30×10.24×3.94	BC-A□P-162610	BC-C□P-162610	1626 S	1626 P	129	224
160×260×130	6.30×10.24×5.12	BC-A□P-162613	BC-C□P-162613	1626 S	1626 P	129	224
170×220×110	6.69×8.66×4.33	BC-A□P-172211	BC-C□P-172211	1722 S	1722 P	129	179
170×270×110	6.69×10.63×4.33	BC-A□P-172711	BC-C□P-172711	1727 S	1727 P	129	224
210×210×100	8.27×8.27×3.94	BC-A□P-212110	BC-C□P-212110	2121 S	2121 P	179	179
210×210×130	8.27×8.27×5.12	BC-A□P-212113	BC-C□P-212113	2121 S	2121 P	179	179
190×280×100	7.48×11.02×3.94	BC-A□P-192810	BC-C□P-192810	1928 S	1928 P	159	248
190×280×140	7.48×11.02×5.51	BC-A□P-192814	BC-C□P-192814	1928 S	1928 P	159	248
200×300×130	7.87×11.81×5.12	BC-A□P-203013	BC-C□P-203013	2030 S	2030 P	166	266
200×300×150	7.87×11.81×5.91	BC-A□P-203015	BC-C□P-203015	2030 S	2030 P	166	266
200×300×180	7.87×11.81×7.09	BC-A□P-203018	BC-C□P-203018	2030 S	2030 P	166	266
250×350×150	9.84×13.78×5.91	BC-A□P-253515	BC-C□P-253515	2535 S	2535 P	216	316
250×350×180	9.84×13.78×7.09	BC-A□P-253518	BC-C□P-253518	2535 S	2535 P	216	316
280×280×130	11.02×11.02×5.12	BC-A□P-282813	BC-C□P-282813	2828 S	2828 P	248	248
280×380×130	11.02×14.96×5.12	BC-A□P-283813	BC-C□P-283813	2838 S	2838 P	248	348
300×300×150	11.81×11.81×5.91	BC-A□P-303015	BC-C□P-303015	3030 S	3030 P	262	262
300×300×180	11.81×11.81×7.09	BC-A□P-303018	BC-C□P-303018	3030 S	3030 P	262	262
300×400×120	11.81×15.75×4.72	BC-A□P-304012	BC-C□P-304012	3040 S	3040 P	265	365
300×400×150	11.81×15.75×5.91	BC-A□P-304015	BC-C□P-304015	3040 S	3040 P	265	365
300×400×180	11.81×15.75×7.09	BC-A□P-304018	BC-C□P-304018	3040 S	3040 P	265	365
350×350×150	13.78×13.78×5.91	BC-A□P-353515	BC-C□P-353515	3535 S	3535 P	320	320
350×350×180	13.78×13.78×7.09	BC-A□P-353518	BC-C□P-353518	3535 S	3535 P	320	320
350×450×120	13.78×17.72×4.72	BC-A□P-354512	BC-C□P-354512	3545 S	3545 P	306	407
350×450×160	13.78×17.72×6.30	BC-A□P-354516	BC-C□P-354516	3545 S	3545 P	306	407
350×450×200	13.78×17.72×7.87	BC-A□P-354520	BC-C□P-354520	3545 S	3545 P	306	407
400×500×160	15.75×19.69×6.30	BC-A□P-405016	BC-C□P-405016	4050 S	4050 P	358	458
400×500×200	15.75×19.69×7.87	BC-A□P-405020	BC-C□P-405020	4050 S	4050 P	358	458
400×600×180	15.75×23.62×7.09	BC-A□P-406018	BC-C□P-406018	4060 S	4060 P	358	558
400×600×230	15.75×23.62×9.06	BC-A□P-406023	BC-C□P-406023	4060 S	4060 P	358	558
530×630×185	20.87×24.80×7.28	BC-A□P-506018	BC-C□P-506018	5060 S	5060 P	450	555
530×630×255	20.87×24.80×10.04	BC-A□P-506025	BC-C□P-506025	5060 S	5060 P	450	555
530×730×185	20.87×28.74×7.28	BC-A□P-507018	BC-C□P-507018	5070 S	5070 P	450	655
530×730×255	20.87×28.74×10.04	BC-A□P-507025	BC-C□P-507025	5070 S	5070 P	450	655
630×830×185	24.80×32.68×7.28	BC-A□P-608018	BC-C□P-608018	6080 S	6080 P	550	755
630×830×285	24.80×32.68×11.22	BC-A□P-608028	BC-C□P-608028	6080 S	6080 P	550	755

전용 액세서리 Accessories



■ 철속판(아연도금)
Steel mounting plate(Zinc plating)



■ 플라스틱속판(ABS)
Plastic mounting plate (ABS)



■ 자물쇠 걸이(K40)
Key ring (K40)



■ 잠금장치(SK)
Locker (SK)



■ 플라스틱잠금장치(PK)
Plastic locker(PK)



■ 잠금장치 일체형
매미고리(PSK)



■ 브라켓(B40,B50,B60)
SUS bracket (B40, B50, B60)



■ 환기구(V60, V80)
Vent(V60, V80)



■ 플라스틱 브라켓(PB40, 50)
Plastic bracket (PB40, 50)

H시리즈 (힌지 타입) 중 · 대형 사이즈

H Series - Medium and large size



*속판 규격은 플라스틱 속판 기준이며, ()안은 철 속판 규격임.
The dimension of mounting plate is based on the plastic mounting plate and the dimension of around bracket is steel mounting plate

Dimension (허용오차 ±1mm)

	Division	Size										
		W1	W2	W3	W4	H1	H2	H3	H4	D1	D2	D3
BASE	225 × 275 × 120	225	201	183	160	276	253	234	210	90	30	98
	275 × 225 × 120	276	253	234	210	225	201	183	160	90	30	98
	200 × 300 × 150	200	176	152	129	300	276	252	226	120	30	128.5
	300 × 200 × 150	300	276	252	226	200	176	152	129	120	30	128.5
COVER BASE	200 × 300 × 180	200	176	152	129	300	276	252	226	150	30	158.5
	300 × 200 × 180	300	276	252	226	200	176	152	129	150	30	158.5
	250 × 350 × 150	250	228	206	180	350	328	306	269	120	30	128.5
	350 × 250 × 150	350	328	306	269	250	228	206	180	120	30	128.5
COVER + BASE	300 × 400 × 150	300	275	252	230	400	375	352	325	120	30	128
	400 × 300 × 150	400	375	352	325	300	275	252	230	120	30	128
	300 × 400 × 180	300	275	252	230	400	375	352	325	150	30	158
	400 × 300 × 180	400	375	352	325	300	275	252	230	150	30	158
MOUNTING PLATE (속판)	400 × 300 × 180	400	375	352	325	300	275	252	230	150	30	158
	350 × 450 × 160	350	320	302	280	450	420	402	375	130	30	138
	450 × 350 × 160	450	420	402	375	350	320	302	280	130	30	138
	350 × 450 × 200	350	320	302	280	450	420	402	375	170	30	178
방수,방진 보호등급	IP 66/67											
충격 테스트	IK 07/08											
온도 영역	ABS : -40~+85 PC : -40~+120											
난연성	ABS : 94-HB PC/ABS:94-V-0~5VA											
	PC : 94-HB, 94-V-0~5VA											
	400 × 600 × 230	402	370	352	328	602	570	552	525	200	30	208
600 × 400 × 230	602	570	552	525	402	370	352	328	200	30	208	

제품특징 Product characteristics

1. 스테인레스 재질의 힌지, 매미고리가 장착되어 개폐빈도가 높아도 파손이 거의 없습니다.
 2. 제품 사이즈의 증가에 따라 힌지, 매미고리의 크기를 상향시켜 개폐시 처짐을 방지하며 완벽한 밀폐력을 확보하였습니다.
 3. 고충격에 강한 재질과 제품의 구조를 더욱 보강하여 열악하고 위험한 산업현장에서도 적용되어 사용가능 하도록 만들었습니다.
1. It will not be damaged even using for a long time because stainless steel hinge and draw latch are equipped.
 2. It secures perfect airtightness by preventing sink down when opening or closing by increasing the sizes of hinge and draw latch by size increasing of the products.
 3. It can be used in inferior or dangerous industrial field by using strong material and structure.



모델규격 Model and size

Model and size (cover included)		제품모델 Product model		속판모델 Plate Model		속판규격 Plate Size	
Width×Length×Height (mm)	Width×Length×Height (inch)	ABS	PC	Steel mounting plate 1.6mm	Plastic mounting plate 3~4.5mm	M1	M2
		G:Grey Cover,T:Transparent Cover	G:Grey Cover,T:Transparent Cover				
225×275×120	8.86×10.83×4.72	BC-A□H-222712	BC-C□H-222712	2227 S	2227 P	190	242
275×225×120	10.83×8.86×4.72	BC-A□H-272212	BC-C□H-272212	2227 S	2227 P	190	242
200×300×150	7.87×11.81×5.91	BC-A□H-203015	BC-C□H-203015	2030 S	2030 P	166	266
300×200×150	11.81×7.87×5.91	BC-A□H-302015	BC-C□H-302015	2030 S	2030 P	166	266
200×300×180	7.87×11.81×7.09	BC-A□H-203018	BC-C□H-203018	2030 S	2030 P	166	266
300×200×180	11.81×7.87×7.09	BC-A□H-302018	BC-C□H-302018	2030 S	2030 P	166	266
250×350×150	9.84×13.78×5.91	BC-A□H-253515	BC-C□H-253515	2535 S	2535 P	216	316
350×250×150	13.78×9.84×5.91	BC-A□H-352515	BC-C□H-352515	2535 S	2535 P	216	316
300×400×150	11.81×15.75×5.91	BC-A□H-304015	BC-C□H-304015	3040 S	3040 P	265	365
400×300×150	15.75×11.81×5.91	BC-A□H-403015	BC-C□H-403015	3040 S	3040 P	265	365
300×400×180	11.81×15.75×7.09	BC-A□H-304018	BC-C□H-304018	3040 S	3040 P	265	365
400×300×180	15.75×11.81×7.09	BC-A□H-403018	BC-C□H-403018	3040 S	3040 P	265	365
350×450×160	13.78×17.72×6.30	BC-A□H-354516	BC-C□H-354516	3545 S	3545 P	306	407
450×350×160	17.72×13.78×6.30	BC-A□H-453516	BC-C□H-453516	3545 S	3545 P	306	407
350×450×200	13.78×17.72×7.87	BC-A□H-354520	BC-C□H-354520	3545 S	3545 P	306	407
450×350×200	17.72×13.78×7.87	BC-A□H-453520	BC-C□H-453520	3545 S	3545 P	306	407
400×500×200	15.75×19.69×7.87	BC-A□H-405020	BC-C□H-405020	4050 S	4050 P	358	458
500×400×200	19.69×15.75×7.87	BC-A□H-504020	BC-C□H-504020	4050 S	4050 P	358	458
400×600×230	15.75×23.62×9.06	BC-A□H-406023	BC-C□H-406023	4060 S	4060 P	358	558
600×400×230	23.62×15.75×9.06	BC-A□H-604023	BC-C□H-604023	4060 S	4060 P	358	558

* 600×400×230은 비방수용입니다. 600×400×230 is for non water proof product.

전용 액세서리 Accessories

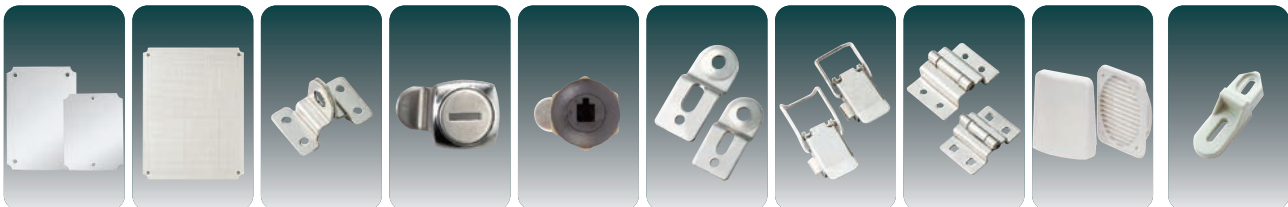

- 철속판(아연도금) Steel mounting plate(Zinc plating)
- 플라스틱속판(ABS) Plastic mounting plate (ABS)
- 자물쇠 걸이(K40) Key ring (K40)
- 잠금장치(SK) Locker (SK)
- 플라스틱잠금장치(PK) Plastic locker(PK)
- 브라켓(B50,B60) SUS bracket (B50, B60)
- 매미고리(L75,L65) Draw latch(L65, L75)
- 힌지(H75, H65) Hinge(H65, H75)
- 환기구(V60, V80) Vent(V60, V80)
- 플라스틱 브라켓(PB50) Plastic bracket(PB50)

H시리즈 (힌지 타입) 중형 사이즈

H Series - Medium size



*속판 규격은 플라스틱 속판 기준이며, ()안은 철 속판 규격임.
The dimension of mounting plate is based on the plastic mounting plate and the dimension of around bracket is steel mounting plate

Dimension (허용오차 ±1mm)

Division	W1	W2	W3	W4	H1	H2	H3	H4	D1	D2	D3
190×190×130	190	169	90	120	190	169	150	120	98	30	112
190×280×130	190	169	150	120	280	259	182	210	98	30	112
280×190×130	280	259	182	210	190	169	150	120	98	30	112
190×280×180	190	169	150	120	280	259	182	210	150	30	159
280×190×180	280	259	182	210	190	169	150	210	150	30	159
190×380×130	190	169	150	120	380	359	282	310	98	30	109
380×190×130	380	359	282	310	190	169	150	120	98	30	109
190×380×180	190	169	150	120	380	359	282	310	150	30	159
380×190×180	380	359	282	310	190	169	150	210	150	30	159
280×280×130	280	259	183	210	280	259	240	210	98	30	112
280×340×130	280	258	240	210	340	318	244	270	100	30	111
340×280×130	340	318	244	270	280	258	240	210	100	30	111
280×380×130	280	259	240	210	380	359	284	310	98	30	111
380×280×130	380	359	284	310	280	259	240	210	98	30	111
280×380×180	280	259	240	210	380	359	284	310	148	30	161.5
380×280×180	380	359	284	310	280	259	240	210	148	30	161.5
280×560×130	280	259	240	210	560	535	460	490	100	30	120
560×280×130	560	535	460	490	280	259	240	210	100	30	120
330×430×180	330	305	290	260	430	405	335	360	150	30	160
430×330×180	430	405	335	360	330	305	290	260	150	30	160
380×560×180	380	355	340	310	560	535	460	490	150	30	160
560×380×180	560	535	460	490	380	355	340	310	150	30	160

방수,방진 보호등급	IP 66/67
충격테스트	IK 07/08
온도영역	ABS: -40~+85 PC: -40~+120
난연성	ABS: 94-HB PC/ABS: 94-V-0~5VA PC: 94-HB, 94-V-0~5VA

제품특징 Product characteristics

1. 스테인레스 재질의 힌지, 매미고리가 장착되어 개폐빈도가 높아도 파손이 거의 없습니다.
 2. 제품 설계시부터 볼트개폐형과 스테인레스 재질의 힌지, 매미고리 장착을 고려하여 만든 제품으로 밀폐력이 우수합니다.
 3. 사용자의 편의에 의하여 직접 고리를 장착할 시에도 간단하게 장착할 위치에 쉽게 타공할 수 있도록 기능을 추가하여 만든 제품입니다.
1. It will not be damaged even using for a long time because stainless steel hinge and draw latch are equipped.
 2. It has excellent airtightness as it was designed considering bolt open/close type, hinge made of stainless steel and equipment of draw latch.
 3. User make hole on the place of equipment simply.



모델규격 Model and size

Model and size (cover included)		제품모델 Product model		속판모델 Plate Model		속판규격 Plate Size	
Width×Length×Height (mm)	Width×Length×Height (inch)	ABS	PC	Steel mounting plate 1.6mm	Plastic mounting plate 3~4.5mm	M1	M2
		G:Grey Cover, T:Transparent Cover UL CE	G:Grey Cover, T:Transparent Cover UL CE				
190×190×130	7.48×7.48×5.12	BC-A□H-191913	BC-C□H-191913	1919 S	1919 P	159	159
190×280×130	7.48×11.02×5.12	BC-A□H-192813	BC-C□H-192813	1928 S	1928 P	159	248
280×190×130	11.02×7.48×5.12	BC-A□H-281913	BC-C□H-281913	2819 S	2819 P	159	248
190×280×180	7.48×11.02×7.09	BC-A□H-192818	BC-C□H-192818	1928 S	1928 P	159	248
280×190×180	11.02×7.48×7.09	BC-A□H-281918	BC-C□H-281918	2819 S	2819 P	159	248
190×380×130	7.48×14.96×5.12	BC-A□H-193813	BC-C□H-193813	1938 S	1938 P	159	348
380×190×130	14.96×7.48×5.12	BC-A□H-381913	BC-C□H-381913	3819 S	3819 P	159	348
190×380×180	7.48×14.96×7.09	BC-A□H-193818	BC-C□H-193818	1938 S	1938 P	159	348
380×190×180	14.96×7.48×7.09	BC-A□H-381918	BC-C□H-381918	3819 S	3819 P	159	348
280×280×130	11.02×11.02×5.12	BC-A□H-282813	BC-C□H-282813	2828 S	2828 P	248	248
280×340×130	11.02×13.39×5.12	BC-A□H-283413	BC-C□H-283413	2834 S	2834 P	248	308
340×280×130	13.39×11.02×5.12	BC-A□H-342813	BC-C□H-342813	3428 S	3428 P	308	248
280×380×130	11.02×14.96×5.12	BC-A□H-283813	BC-C□H-283813	2838 S	2838 P	248	348
380×280×130	14.96×11.02×5.12	BC-A□H-382813	BC-C□H-382813	3828 S	3828 P	248	348
280×380×180	11.02×14.96×7.09	BC-A□H-283818	BC-C□H-283818	2838 S	2838 P	248	348
380×280×180	14.96×11.02×7.09	BC-A□H-382818	BC-C□H-382818	3828 S	3828 P	348	348
280×560×130	11.02×22.05×5.12	BC-A□H-285613	BC-C□H-285613	2856 S		(232)	(535)
560×280×130	22.05×11.02×5.12	BC-A□H-562813	BC-C□H-562813	5828 S		(232)	(535)
330×430×180	12.99×16.93×7.09	BC-A□H-334318	BC-C□H-334318	3343 S	3343 P	(295)	(395)
430×330×180	16.93×12.99×7.09	BC-A□H-433318	BC-C□H-433318	4333 S	3343 P	(295)	(395)
380×560×180	14.96×22.05×7.09	BC-A□H-385618	BC-C□H-385618	3856 S		(345)	(535)
560×380×180	22.05×14.96×7.09	BC-A□H-563818	BC-C□H-563818	5638 S		(345)	(535)

*560×280×130, 560×380×180은 비방수용입니다. 560×280×130, 560×380×180 is for non water proof product.

전용 액세서리 Accessories

■철속판(아연도금) Steel mounting plate(Zinc plating)	■플라스틱속판(ABS) Plastic mounting plate(ABS)	■자물쇠 걸이(K40) Key ring (K40)	■잠금장치(SK) Lock (SK)	■플라스틱잠금장치(PK) Plastic locker (PK)
■잠금장치(B50) SUS bracket (B50)	■매미고리(L65) Draw latch (L65)	■힌지(H65) Hinge (H65)	■마개(M22) Stopper (M22)	■환기구(V60, V80) Vent(V60, V80)
				■플라스틱 브라켓(PB50) Plastic bracket(PB50)

H시리즈 (힌지 타입) 소형 사이즈

H Series - Small size



*속판 규격은 플라스틱 속판 기준이며, ()안은 철 속판 규격임.
The dimension of mounting plate is based on the plastic mounting plate and the dimension of around bracket is steel mounting plate

Dimension (허용오차 ±1mm)

	Division	Size										
		W1	W2	W3	W4	H1	H2	H3	H4	D1	D2	D3
BASE	80×110×70	80	71	62	0	110	101	92	80	50	20	53
	110×80×70	110	101	92	80	80	71	62	0	0	20	20
COVER	80×110×85	80	71	62	0	110	101	92	80	0	0	0
	110×80×85	110	101	92	80	80	71	62	0	0	0	0
BASE	80×110×100	80	71	62	0	110	101	92	80	0	0	0
	110×80×100	110	101	92	80	80	71	62	0	0	0	0
COVER + BASE	80×130×70	80	71	62	0	130	121	112	100	0	0	0
	130×80×70	130	121	112	100	80	71	62	0	0	0	0
BASE	80×130×85	80	71	62	0	130	121	112	100	0	0	0
	130×80×85	130	121	112	100	80	71	62	0	0	0	0
COVER + BASE	80×180×70	80	71	62	0	180	171	162	150	0	0	0
	180×80×70	180	171	162	150	80	71	62	0	0	0	0
BASE	80×180×85	80	71	62	0	180	171	162	150	0	0	0
	180×80×85	180	171	162	150	80	71	62	0	0	0	0
COVER + BASE	80×250×70	80	71	62	0	250	241	232	220	0	0	0
	250×80×70	250	241	232	220	80	71	62	0	0	0	0
BASE	80×250×85	80	71	62	0	250	241	232	220	0	0	0
	250×80×85	250	241	232	220	80	71	62	0	0	0	0
COVER + BASE	100×100×75	101	101	92	0	100	92	83	60	0	0	0
	100×100×100	101	101	92	0	100	92	83	60	0	0	0
COVER + BASE	125×125×75	125	125	116	0	125	117	108	70	0	0	0
	125×125×100	125	125	116	0	125	117	108	70	0	0	0
COVER + BASE	125×125×100	127	127	118	140	127	119	110	140	0	0	0
	125×125×100	127	127	118	140	127	119	110	140	0	0	0
COVER + BASE	140×140×75	140	140	131	130	140	132	123	130	0	0	0
	140×140×100	140	140	131	130	140	132	123	130	0	0	0
COVER + BASE	140×230×95	140	131	122	0	230	221	212	190	0	0	0
	230×140×95	230	221	212	200	140	131	122	110	0	0	0
COVER + BASE	150×150×75	150	141	132	0	150	141	132	110	0	0	0
	150×150×100	150	141	132	0	150	141	132	110	0	0	0
COVER + BASE	150×200×75	150	140	131	160	200	191	182	160	0	0	0
	200×150×75	200	191	182	160	150	140	131	110	0	0	0
COVER + BASE	150×200×100	150	140	131	160	200	191	182	160	110	20	111
	200×150×100	200	191	182	160	150	140	131	110	110	20	111
COVER + BASE	150×250×160	150	140	131	160	250	241	232	210	0	0	0
	250×150×160	250	241	232	210	150	141	132	110	0	0	0
COVER + BASE	150×250×100	150	141	132	0	250	241	232	210	80	50	83
	250×150×100	250	241	232	210	150	141	132	110	80	50	83
COVER + BASE	150×250×130	150	141	132	0	250	241	232	210	80	50	113
	250×150×130	250	241	232	210	150	141	132	110	80	50	113
COVER + BASE	200×200×100	200	190	182	150	200	190	182	120	80	20	82
	200×200×130	200	190	182	150	200	190	182	120	110	20	111
COVER + BASE	200×200×160	200	190	182	150	200	190	182	120	140	20	141
	200×200×190	200	190	182	150	200	190	182	120	140	20	141
COVER + BASE	210×230×100	210	201	192	160	230	221	212	180	80	20	87
	230×210×100	230	221	212	180	210	201	192	160	80	20	87

제품특징 Product characteristics

1. 스테인레스 재질의 힌지, 매미고리가 장착되어 개폐빈도가 높아도 파손이 거의 없습니다.
2. 공장 출고시 정확한 위치에 가공후 고리를 장착하므로 완벽한 밀폐력과 개폐의 편리성을 확보한 제품입니다.
3. 두께의 보강과 구조를 더욱 보완하여 장기간 사용이 가능하도록 만들었습니다.



1. It will not be damaged even using for a long time because stainless steel hinge and draw latch are equipped.
2. Ring is equipped at correct place after processing so that it has perfect airtight and convenience to open and close.
3. We reinforce the thickness and structure to be used longer time.



모델규격 Model and size

Model and size (cover included)		제품모델 Product model		속판모델 Plate Model		속판규격 Plate Size	
Width×Length×Height (mm)	Width×Length×Height (inch)	ABS	PC	Steel mounting plate 1.6mm	Plastic mounting plate 3~4.5mm	M1	M2
		G:Grey Cover, T:Transparent Cover 	G:Grey Cover, T:Transparent Cover 				
80×110×70	3.15×4.33×2.76	BC-A□H-081107	BC-C□H-081107	0811 S	0811 P	64	94
110×80×70	4.33×3.15×2.76	BC-A□H-110807	BC-C□H-110807	1108 S	1108 P	64	94
80×110×85	3.15×4.33×3.35	BC-A□H-081108	BC-C□H-081108	0811 S	0811 P	64	94
110×80×85	4.33×3.15×3.35	BC-A□H-110808	BC-C□H-110808	1108 S	1108 P	64	94
80×110×100	3.15×4.33×3.94	BC-A□H-081110	BC-C□H-110810	0811 S	0811 P	64	94
110×80×100	4.33×3.15×3.94	BC-A□H-110810	BC-C□H-110808	1108 S	1108 P	64	94
80×130×70	3.15×5.12×2.76	BC-A□H-081307	BC-C□H-081307	0813 S	0813 P	65	115
130×80×70	5.12×3.15×2.76	BC-A□H-130807	BC-C□H-130807	1308 S	1308 P	65	115
80×130×85	3.15×5.12×3.35	BC-A□H-081308	BC-C□H-081308	0813 S	0813 P	65	115
130×80×85	5.12×3.15×3.35	BC-A□H-130808	BC-C□H-130808	1308 S	1308 P	65	115
80×180×70	3.15×7.09×2.76	BC-A□H-081807	BC-C□H-081807	0818 S	0818 P	65	165
180×80×70	7.09×3.15×2.76	BC-A□H-180807	BC-C□H-180807	1808 S	1808 P	65	165
80×180×85	3.15×7.09×3.35	BC-A□H-081808	BC-C□H-081808	0818 S	0818 P	65	165
180×80×85	7.09×3.15×3.35	BC-A□H-180808	BC-C□H-180808	1808 S	1808 P	65	165
80×250×70	3.15×9.84×2.76	BC-A□H-082507	BC-C□H-082507	0825 S	0825 P	65	235
250×80×70	9.84×3.15×2.76	BC-A□H-250807	BC-C□H-250807	2508 S	2508 P	65	235
80×250×85	3.15×9.84×3.35	BC-A□H-082508	BC-C□H-082508	0825 S	0825 P	65	235
250×80×85	9.84×3.15×3.35	BC-A□H-250808	BC-C□H-250808	2508 S	2508 P	65	235
100×100×75	3.94×3.94×2.95	BC-A□H-101007	BC-C□H-101007	1010 S	1010 P	82	82
100×100×100	3.94×3.94×3.94	BC-A□H-101010	BC-C□H-101010	1010 S	1010 P	82	82
125×125×75	4.92×4.92×2.95	BC-A□H-121207	BC-C□H-121207	1212 S	1212 P	107	107
125×125×100	4.92×4.92×3.94	BC-A□H-121210	BC-C□H-121210	1212 S	1212 P	107	107
125×175×75	4.92×6.89×2.95	BC-A□H-121707	BC-C□H-121707	1217 S	1217 P	113	161
175×125×75	6.89×4.92×2.95	BC-A□H-171207	BC-C□H-171207	1712 S	1712 P	113	161
125×175×100	4.92×6.89×3.94	BC-A□H-121710	BC-C□H-121710	1217 S	1217 P	113	161
175×125×100	6.89×4.92×3.94	BC-A□H-171210	BC-C□H-171210	1712 S	1712 P	113	161
140×170×95	5.51×6.69×3.74	BC-A□H-141709	BC-C□H-141709	1417 S	1417 P	126	155
170×140×95	6.69×5.51×3.74	BC-A□H-171409	BC-C□H-171409	1714 S	1714 P	126	155
140×230×95	5.51×9.06×3.74	BC-A□H-142309	BC-C□H-142309	1423 S	1423 P	122	212
230×140×95	9.06×5.51×3.74	BC-A□H-231409	BC-C□H-231409	2314 S	2314 P	122	212
150×150×75	5.91×5.91×2.95	BC-A□H-151507	BC-C□H-151507	1515 S	1515 P	123	123
150×150×100	5.91×5.91×3.94	BC-A□H-151510	BC-C□H-151510	1515 S	1515 P	123	123
150×200×75	5.91×7.87×2.95	BC-A□H-152007	BC-C□H-152007	1520 S	1520 P	129	179
200×150×75	7.87×5.91×2.95	BC-A□H-201507	BC-C□H-201507	2015 S	2015 P	129	179
150×200×100	5.91×7.87×3.94	BC-A□H-152010	BC-C□H-152010	1520 S	1520 P	129	179
200×150×100	7.87×5.91×3.94	BC-A□H-201510	BC-C□H-201510	2015 S	2015 P	129	179
150×200×130	5.91×7.87×5.12	BC-A□H-152013	BC-C□H-152013	1520 S	1520 P	129	179
200×150×130	7.87×5.91×5.12	BC-A□H-201513	BC-C□H-201513	2015 S	2015 P	129	179
150×200×160	5.91×7.87×6.30	BC-A□H-152016	BC-C□H-152016	2020 S	2020 P	129	179
200×150×160	7.87×5.91×6.30	BC-A□H-201516	BC-C□H-201516	2020 S	2020 P	129	179
150×250×100	5.91×9.84×3.94	BC-A□H-152510	BC-C□H-152510	1525 S	1525 P	129	224
250×150×100	9.84×5.91×3.94	BC-A□H-251510	BC-C□H-251510	2515 S	2515 P	129	224
150×250×130	5.91×9.84×5.12	BC-A□H-152513	BC-C□H-152513	1525 S	1525 P	129	224
250×150×130	9.84×5.91×5.12	BC-A□H-251513	BC-C□H-251513	2515 S	2515 P	129	224
200×200×100	7.87×7.87×3.94	BC-A□H-202010	BC-C□H-202010	2020 S	2020 P	179	179
200×200×130	7.87×7.87×5.12	BC-A□H-202013	BC-C□H-202013	2020 S	2020 P	179	179
200×200×160	7.87×7.87×6.30	BC-A□H-202016	BC-C□H-202016	2020 S	2020 P	179	179
200×200×190	7.87×7.87×7.48	BC-A□H-202019	BC-C□H-202019	2020 S	2020 P	179	179
210×230×100	8.27×9.06×3.94	BC-A□H-212310	BC-C□H-212310	2123 S		196.5	216
230×210×100	9.06×8.27×3.94	BC-A□H-232110	BC-C□H-232110	2123 S		196.5	216

전용 액세서리 Accessories



- 철속판(아연도금) Steel mounting plate(Zinc plating)
- 플라스틱속판(ABS) Plastic mounting plate (ABS)
- 자물쇠 걸이(K40) Key ring (K40)
- 잠금장치(SK) Locker(SK)
- 플라스틱잠금장치(PK) Plastic locker(PK)
- 매미고리(L55) Draw latch(L55)
- 힌지(H55) Hinge(H55)
- 마개(M11) Stopper(M11)
- 브라켓(B40) SUS bracket (B40)
- 환기구(V80, V60) Vent(V60, V80)
- 플라스틱 브라켓(PB40) Plastic bracket(PB40)

S시리즈 (스크류 볼트타입) 중형 사이즈

S Series - Medium size



*속판 규격은 플라스틱 속판 기준이며, ()안은 철 속판 규격임.
The dimension of mounting plate is based on the plastic mounting plate and the dimension of around bracket is steel mounting plate

Dimension (허용오차 ±1mm)

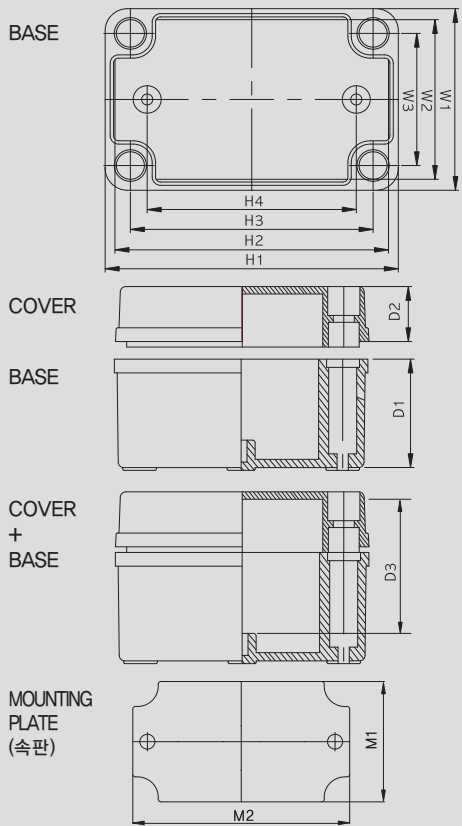

Division	W1	W2	W3	W4	H1	H2	H3	H4	D1	D2	D3
190×190×130	190	169	90	120	190	169	150	120	98	30	112
190×280×130	190	169	150	120	280	259	182	210	98	30	112
190×280×180	190	169	150	120	280	259	182	210	150	30	159
190×380×130	190	169	150	120	380	359	282	310	98	30	109
190×380×180	190	169	150	120	380	359	282	310	150	30	159
280×280×130	280	259	183	210	280	259	240	210	98	30	112
280×340×130	280	258	240	210	340	318	244	270	100	30	111
280×380×130	280	259	240	210	380	359	284	310	98	30	111
280×380×180	280	259	240	210	380	359	284	310	150	30	161.5
280×560×130	280	259	240	210	560	535	460	490	100	30	120
330×430×180	330	305	290	260	430	405	335	360	150	30	160
380×560×180	380	355	340	310	560	535	460	490	150	30	160

방수,방진 보호등급	IP 66/67
충격테스트	IK 07/08
온도영역	ABS : -40~+85 PC : -40~+120
난연성	ABS : 94-HB PC/ABS : 94-V-0~5VA PC : 94-HB, 94-V-0~5VA

제품특징 Product characteristics

1. 베이스의 커버볼트 체결용 나사산은 사출 형성시 베이스에 일체형으로 성형된 것으로 강도가 우수하며 볼트체결시 뭉개짐이 없이 견고합니다.
 2. 충격에 강하도록 제품 설계시 사면 슬라이드 방식으로 생산한 제품이므로 탁월한 견고성을 보장합니다.
1. Screw thread for connecting cover bolt of the base is inserted into the base in injection molding so that it has sufficient strength and not broken when tightening bolt.
 2. It is designed as 4 side sliding type to be strong against impact.



모델규격 Model and size

Model and size (cover included)		제품모델 Product model		속판모델 Plate Model		속판규격 Plate Size	
Width×Length×Height (mm)	Width×Length×Height (inch)	ABS	PC	Steel mounting plate 1.6mm	Plastic mounting plate 3~4.5mm	M1	M2
		G:Grey Cover, T:Transparent Cover UL CE	G:Grey Cover, T:Transparent Cover UL CE				
190×190×130	7.48×7.48×5.12	BC-A□S-191913	BC-C□S-191913	1919 S	1919 P	159	159
190×280×130	7.48×11.02×5.12	BC-A□S-192813	BC-C□S-192813	1928 S	1928 P	159	248
190×280×180	7.48×11.02×7.09	BC-A□S-192818	BC-C□S-192818	1928 S	1928 P	159	248
190×380×130	7.48×14.96×5.12	BC-A□S-193813	BC-C□S-193813	1938 S	1938 P	159	348
190×380×180	7.48×14.96×7.09	BC-A□S-193818	BC-C□S-193818	1938 S	1938 P	159	348
280×280×130	11.02×11.02×5.12	BC-A□S-282813	BC-C□S-282813	2828 S	2828 P	248	248
280×340×130	11.02×13.39×5.12	BC-A□S-283413	BC-C□S-283413	2834 S	2834 P	248	308
280×380×130	11.02×14.96×5.12	BC-A□S-283813	BC-C□S-283813	2838 S	2838 P	248	348
280×380×180	11.02×14.96×7.09	BC-A□S-283818	BC-C□S-283818	2838 S	2838 P	248	348
280×560×130	11.02×22.05×5.12	BC-A□S-285613	BC-C□S-285613	2856 S		(232)	(535)
330×430×180	12.99×16.93×7.09	BC-A□S-334318	BC-C□S-334318	3343 S	3343 P	(295)	(395)
380×560×180	14.96×22.05×7.09	BC-A□S-385618	BC-C□S-385618	3856 S		(345)	(535)

전용 액세서리 Accessories



- 철속판(아연도금) Steel mounting plate (Zinc plating)
- 플라스틱속판(ABS) Plastic mounting plate (ABS)
- 커버볼트(표준제공)(CB28-) Cover bolt(standard provide)(CB28-)
- 커버볼트(선택시양)(CB28+) Cover bolt(optional)(CB28+)
- 브라켓(B50) SUS bracket(B50)
- 환기구(V60, V80) Vent(V60, V80)
- 플라스틱 브라켓(PB50) Plastic bracket(PB50)



S시리즈 (스크류 볼트타입) 소형 사이즈

S Series - Small size



*속판 규격은 플라스틱 속판 기준이며, ()안은 철 속판 규격임.
The dimension of mounting plate is based on the plastic mounting plate and the dimension of around bracket is steel mounting plate

Dimension (허용오차 ±1mm)

BASE		Division				H1	H2	H3	H4	D1	D2	D3	
		Size	W1	W2	W3								W4
		50×65×45	50	44	37	0	65	59	52	40	30	15	29.5
		50×65×55	50	44	37	0	65	59	52	40	40	15	39.5
		65×95×55	65	56	47	0	95	86	77	65	40	15	39.5
		75×105×55	75	66	57	0	105	96	87	75	40	15	39.5
		80×80×60	80	71	62	0	80	71	62	50	45	15	43
		80×110×45	80	71	62	0	110	101	92	80	25	20	28
		80×110×70	80	71	62	0	110	101	92	80	50	20	53
		80×110×85	80	71	62	0	110	101	92	80	65	20	68
		80×110×100	80	71	62	0	110	101	92	80	65	35	83
		80×130×70	80	71	62	0	130	121	112	100	50	20	53
		80×130×85	80	71	62	0	130	121	112	100	50	35	68
		80×160×55	82	74	50	0	162	154	148	137	40	15	38
		80×160×85	82	74	50	0	162	154	148	137	70	15	68
		80×180×70	80	71	62	0	180	171	162	150	50	20	53
		80×180×85	80	71	62	0	180	171	162	150	50	35	68
		80×250×70	80	71	62	0	250	241	232	220	50	20	52
		80×250×85	80	71	62	0	250	241	232	220	50	35	67
		100×100×75	101	92	82	0	101	92	82	60	55	20	58
		100×100×100	101	92	82	0	101	92	82	60	80	20	83
		100×185×70	100	91	82	0	185	176	167	139	55	15	53
		100×200×70	100	92	82	0	200	192	182	158	55	15	53
		100×230×70	100	91	82	0	230	221	212	184	55	15	53
		125×125×75	125	115	105	0	125	115	105	70	55	20	58
		125×125×100	125	115	105	0	125	115	105	70	80	20	83
		125×175×75	125	118	109	0	175	166	157	140	50	25	58
		125×175×100	125	118	109	0	175	166	157	140	50	50	83
		140×170×95	143	134	122	0	173	164	152	130	75	20	77
		140×230×95	143	131	122	0	230	221	212	200	75	20	77
		150×150×75	150	140	132	0	200	191	182	160	55	20	28
		150×150×100	150	141	132	0	150	141	132	110	80	20	58
		150×200×45	150	140	132	0	200	191	182	160	25	20	28
		150×200×75	150	140	132	0	200	191	182	160	55	20	58
		150×200×100	150	140	132	0	200	191	182	160	80	20	83
		150×200×130	150	140	132	0	200	191	182	160	110	20	111
		150×200×160	150	140	132	0	200	191	182	160	110	50	149
		150×250×100	150	141	132	0	250	241	232	210	80	20	83
		150×250×130	150	141	132	0	250	241	232	210	80	50	113
		160×160×70	160	151	142	0	160	151	142	120	55	15	53
		200×200×100	200	190	182	150	200	190	182	120	80	20	82
		200×200×130	200	190	182	150	200	190	182	120	110	20	111
		200×200×160	200	190	182	150	200	190	182	120	140	20	141
		200×200×190	200	190	182	150	200	190	182	120	140	50	171
		210×230×100	210	201	192	160	230	221	212	180	80	20	87

방수,방진 보호등급	IP 66/67
충격 테스트	IK 07/08
온도영역	ABS : -40~+85 PC : -40~+120
난연성	ABS : 94-HB PC/ABS : 94-V-0~5VA PC : 94-HB, 94-V-0~5VA

제품특징 Product characteristics

1. 베이스의 커버볼트 체결용 나사산은 사출 형성시 베이스에 일체형으로 성형된 것으로 강도가 우수하며 볼트체결시 뭉개짐이 없이 견고합니다.

2. 전기·전자 부품보호에 역점을 두어 두께를 보강하여 반영구적으로 사용 가능하도록 하였습니다.







1. Screw thread for connecting cover bolt of the base in inserted into the base in injection molding so that it has sufficient strength and not broken when tightening bolt.
2. It can be used semi-permanently as we reinforced thickness.



모델규격 Model and size

Model and size (cover included)		제품모델 Product model		속판모델 Plate Model		속판규격 Plate Size	
Width×Length×Height (mm)	Width×Length×Height (inch)	ABS	PC	Steel mounting plate 1.6mm	Plastic mounting plate 3~4.5mm	M1	M2
		G:Grey Cover,T:Transparent Cover TUV CE	G:Grey Cover,T:Transparent Cover UL TUV CE				
50×65×45	1.97×2.56×1.77	BC-A□S-050604	BC-C□S-050604	0506 S		(52)	(38)
50×65×55	1.97×2.56×2.17	BC-A□S-050605	BC-C□S-050605	0506 S		(52)	(38)
65×95×55	2.56×3.74×2.17	BC-A□S-060905	BC-C□S-060905	0609 S		(50)	(80)
75×105×55	2.95×4.13×2.17	BC-A□S-071005	BC-C□S-071005	0710 S		(60)	(90)
80×80×60	3.15×3.15×2.36	BC-A□S-080806	BC-C□S-080806	0808 S		(65)	(65)
80×110×45	3.15×4.33×1.77	BC-A□S-081104	BC-C□S-081104	0811 S	0811 P	65	95
80×110×70	3.15×4.33×2.76	BC-A□S-081107	BC-C□S-081107	0811 S	0811 P	65	95
80×110×85	3.15×4.33×3.35	BC-A□S-081108	BC-C□S-081108	0811 S	0811 P	65	95
80×110×100	3.15×4.33×3.94	BC-A□S-081110	BC-C□S-081110	0811 S	0811 P	65	95
80×130×70	3.15×5.12×2.76	BC-A□S-081307	BC-C□S-081307	0813 S	0813 P	65	115
80×130×85	3.15×5.12×3.35	BC-A□S-081308	BC-C□S-081308	0813 S	0813 P	65	115
80×160×55	3.15×6.30×2.17	BC-A□S-081605	BC-C□S-081605	0816 S	0816 P	65	152
80×160×85	3.15×6.30×3.35	BC-A□S-081608	BC-C□S-081608	0816 S	0816 P	65	152
80×180×70	3.15×7.09×2.76	BC-A□S-081807	BC-C□S-081807	0818 S	0818 P	65	165
80×180×85	3.15×7.09×3.35	BC-A□S-081808	BC-C□S-081808	0818 S	0818 P	65	165
80×250×70	3.15×9.84×2.76	BC-A□S-082507	BC-C□S-082507	0825 S	0825 P	65	235
80×250×85	3.15×9.84×3.35	BC-A□S-082508	BC-C□S-082508	0825 S	0825 P	65	235
100×100×75	3.94×3.94×2.95	BC-A□S-101007	BC-C□S-101007	1010 S	1010 P	88	89
100×100×100	3.94×3.94×3.94	BC-A□S-101010	BC-C□S-101010	1010 S	1010 P	88	89
100×185×70	3.94×7.28×2.76	BC-A□S-101807	BC-C□S-101807	1018 S	1018 P	(88)	(174)
100×200×70	3.94×7.87×2.76	BC-A□S-102007	BC-C□S-102007	1020 S		(88)	(189)
100×230×70	3.94×9.06×2.76	BC-A□S-102307	BC-C□S-102307	1023 S		(88)	(219)
125×125×75	4.92×4.92×2.95	BC-A□S-121207	BC-C□S-121207	1212 S	1212 P	101	102
125×125×100	4.92×4.92×3.94	BC-A□S-121210	BC-C□S-121210	1212 S	1212 P	101	102
125×175×75	4.92×6.89×2.95	BC-A□S-121707	BC-C□S-121707	1217 S	1217 P	101	156
125×175×100	4.92×6.89×3.94	BC-A□S-121710	BC-C□S-121710	1217 S	1217 P	101	156
140×170×95	5.51×6.69×3.74	BC-A□S-141709	BC-C□S-141709	1417 S	1417 P	122	154
140×230×95	5.51×9.06×3.74	BC-A□S-142309	BC-C□S-142309	1423 S	1423 P	122	211
150×150×75	5.91×5.91×2.95	BC-A□S-151507	BC-C□S-151507	1515 S	1515 P	123	123
150×150×100	5.91×5.91×3.94	BC-A□S-151510	BC-C□S-151510	1515 S	1515 P	123	123
150×200×45	5.91×7.87×1.77	BC-A□S-152004	BC-C□S-152004	1520 S	1520 P	136	186
150×200×75	5.91×7.87×2.95	BC-A□S-152007	BC-C□S-152007	1520 S	1520 P	136	186
150×200×100	5.91×7.87×3.94	BC-A□S-152010	BC-C□S-152010	1520 S	1520 P	136	186
150×200×130	5.91×7.87×5.12	BC-A□S-152013	BC-C□S-152013	1520 S	1520 P	129	179
150×200×160	5.91×7.87×6.30	BC-A□S-152016	BC-C□S-152016	2020 S	2020 P	129	179
150×250×100	5.91×9.84×3.94	BC-A□S-152510	BC-C□S-152510	1525 S	1525 P	136	235
150×250×130	5.91×9.84×5.12	BC-A□S-152513	BC-C□S-152513	1525 S	1525 P	136	235
160×160×70	6.30×6.30×2.76	BC-A□S-161607	BC-C□S-161607	1616 S	1616 P	134	134
200×200×100	7.87×7.87×3.94	BC-A□S-202010	BC-C□S-202010	2020 S	2020 P	187	187
200×200×130	7.87×7.87×5.12	BC-A□S-202013	BC-C□S-202013	2020 S	2020 P	187	187
200×200×160	7.87×7.87×6.30	BC-A□S-202016	BC-C□S-202016	2020 S	2020 P	187	187
200×200×190	7.87×7.87×7.48	BC-A□S-202019	BC-C□S-202019	2020 S	2020 P	187	187
210×230×100	8.27×9.06×3.94	BC-A□S-212310	BC-C□S-212310	2123 S		196.5	216

전용 액세서리 Accessories

							
■ 철속판(아연도금) Steel mounting plate (Zinc plating)	■ 플라스틱속판(ABS) Plastic mounting plate (ABS)	■ 커버볼트(선택사양)(CB20-) Cover bolt(optional) (CB20-)	■ 커버볼트(표준제공)(CB20) Cover bolt(standard provide) (CB20)	■ 커버볼트(표준제공)(CB35) Cover bolt(standard provide) (CB35)	■ 커버볼트(표준제공)(CB50) Cover bolt(standard provide) (CB50)	■ 브라켓(B40) SUS bracket (B40)	■ 플라스틱 브라켓(PB40) plastic bracket(PB40)

M시리즈 (M형 스크류 볼트타입)

M Series



*속판 규격은 플라스틱 속판 기준이며, ()안은 철 속판 규격임.
The dimension of mounting plate is based on the plastic mounting plate and the dimension of around bracket is steel mounting plate

Dimension (허용오차 ±1mm)

Division	Size	W1	W2	W3	H1	H2	H3	D1	D2	D3
BASE	80×130×35	80	62	40	130	112	90	25	10	21.5
	80×130×60	80	62	40	130	112	90	50	10	46.5
	80×130×75	80	62	40	130	112	90	65	10	61.5
	80×130×85	80	62	40	130	112	90	50	35	71.5
	80×130×100	80	62	40	130	112	90	90	10	87.5
	80×130×125	80	112	40	130	112	90	90	35	111.5
COVER BASE	130×130×35	130	112	90	130	112	90	25	10	21.5
	130×130×60	130	112	90	130	112	90	50	10	46.5
	130×180×35	130	112	90	180	162	140	25	10	21.5
	130×180×60	130	132	90	180	162	140	50	10	46.5
	150×180×60	150	162	110.5	180	162	140	50	10	45.5
	180×180×60	180	162	140	180	162	140	50	10	45.5
COVER + BASE	180×180×75	180	162	140	180	162	140	65	10	59.5
	180×180×100	180	162	140	180	162	140	90	10	84.5
	180×180×125	180	162	140	180	162	140	115	10	109.5
COVER + BASE	180×255×75	180	162	140	255	237	201.5	60	15	59.5
	180×255×100	180	162	140	255	237	201.5	85	15	84.5
	180×255×125	180	162	140	255	237	201.5	110	15	109.5
MOUNTING PLATE (속판)										
방수,방진 보호등급	IP 66/67									
충격 테스트	IK 07/08									
온도 영역	ABS : -40~+85 PC : -40~+120									
난연성	ABS : 94-HB PC/ABS : 94-V-0~5VA PC : 94-HB, 94-V-0~5VA									

제품특징 Product characteristics

1. M Type Box는 멤브레인 키보드 부착을 고려하여 커버중앙 표면을 약간 낮추어 설계하였습니다.
 2. 베이스의 커버볼트 체결용 나사산은 사출 형성시 베이스에 일체형으로 성형된 것으로 강도가 우수하며 볼트체결시 뭉개짐이 없이 견고합니다.
 3. 커버는 낮게 베이스는 높게 제작되어 세련되고 안정적인 제품외관을 특징으로 가지고 있습니다.
1. Considering attachment of membrane keyboard, this M type Box is designed to make center surface of the cover slightly lower.
 2. Screw thread for connecting cover bolt of the base is inserted into the base in injection molding so that it has sufficient strength and not broken when tightening bolt.
 3. Cover is low and base is high so that it has refined and stable appearance.



모델규격 Model and size

Model and size (cover included)		제품모델 Product model		속판모델 Plate Model		속판규격 Plate Size	
Width×Length×Height (mm)	Width×Length×Height (inch)	ABS	PC	Steel mounting plate 1.6mm	Plastic mounting plate 3~4.5mm	M1	M2
		G:Grey Cover, T:Transparent Cover	G:Grey Cover, T:Transparent Cover				
80×130×35	3.15×5.12×1.38	BC-A□M-081303	BC-C□M-081303	0813 S		(49)	(98)
80×130×60	3.15×5.12×2.36	BC-A□M-081306	BC-C□M-081306	0813 S		(49)	(98)
80×130×75	3.15×5.12×2.95	BC-A□M-081307	BC-C□M-081307	0813 S		(49)	(98)
80×130×85	3.15×5.12×3.35	BC-A□M-081308	BC-C□M-081308	0813 S		(49)	(98)
80×130×100	3.15×5.12×3.94	BC-A□M-081310	BC-C□M-081310	0813 S		(49)	(98)
80×130×125	3.15×5.12×4.92	BC-A□M-081312	BC-C□M-081312	0813 S		(49)	(98)
130×130×35	5.12×5.12×1.38	BC-A□M-131303	BC-C□M-131303	1313 S		(98)	(98)
130×130×60	5.12×5.12×2.36	BC-A□M-131306	BC-C□M-131306	1313 S		(98)	(98)
130×180×35	5.12×7.09×1.38	BC-A□M-131803	BC-C□M-131803	1318 S	1318 P	113	161
130×180×60	5.12×7.09×2.36	BC-A□M-131806	BC-C□M-131806	1318 S	1318 P	113	161
150×180×60	5.91×7.09×2.36	BC-A□M-151806	BC-C□M-151806	1518 S		(123)	(161)
180×180×60	7.09×7.09×2.36	BC-C□M-181806	BC-C□M-181806	1818 S		(148)	(148)
180×180×75	7.09×7.09×2.95	BC-A□M-181807	BC-C□M-181807	1818 S		(148)	(148)
180×180×100	7.09×7.09×3.94	BC-A□M-181810	BC-C□M-181810	1818 S		(148)	(148)
180×180×125	7.09×7.09×4.92	BC-A□M-181812	BC-C□M-181812	1818 S		(148)	(148)
180×255×75	7.09×10.04×2.95	BC-A□M-182507	BC-C□M-182507	1825 S		(148)	(223)
180×255×100	7.09×10.04×3.94	BC-A□M-182510	BC-C□M-182510	1825 S		(148)	(223)
180×255×125	7.09×10.04×4.92	BC-A□M-182512	BC-C□M-182512	1825 S		(148)	(223)

전용 액세서리 Accessories

■ 철속판(아연도금) Steel mounting plate (Zinc plating)	■ 커버볼트(표준제공)(CB10) Cover bolt(standard provide) (CB10)	■ 커버볼트(선택사양)(CB20-) Cover bolt(optional) (CB20-)	■ 커버볼트(표준제공)(CB20) Cover bolt(standard provide) (CB20)	■ 브라켓(B40) SUS bracket(B40)	■ 플라스틱 브라켓(PB40) Plastic bracket(PB40)



낙아웃 박스

KNOCK-OUT BOX

KNOCK-OUT BOX



Dimension (허용오차 ±1mm)

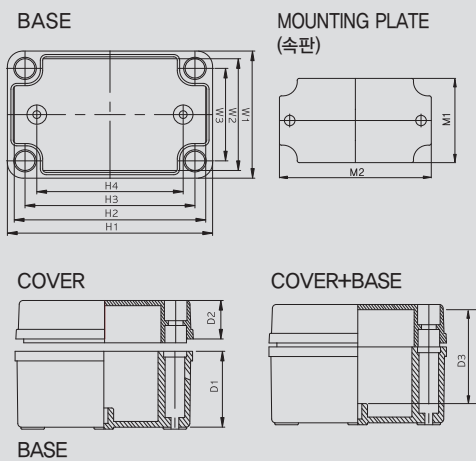

Size	Division	W1	W2	W3	H1	H2	H3	H4	D1	D2	D3
80×110×70		80	74	62	110	104	92	80	50	20	53
80×110×85		80	74	62	110	104	92	80	50	35	68
80×130×70		80	74	62	130	124	112	100	50	20	53
80×130×85		80	74	62	130	124	112	100	50	35	68
80×180×70		80	74	62	180	174	162	150	50	20	53
80×180×85		80	74	62	180	174	162	150	50	35	68
80×250×70		80	74	62	250	244	232	220	50	20	52
80×250×85		80	74	62	250	244	232	220	50	35	67
125×175×75		125	121	109	175	169	157	140	50	25	58
125×175×100		125	121	109	175	169	157	140	50	50	83

방수방진 보호등급	IP 66/67	충격테스트	IK 07/08
온도영역	ABS : -40~+85, PC : -40~+120		
난연성	ABS : 94-HB, PC/ABS : 94-V-0~5VA, PC : 94-HB, 94-V-0~5VA		

모델규격 Model and size

Model and size (cover included)		제품모델 Product model			속판모델 Plate Model		속판규격 Plate Size	
Width×Length×Height (mm)	Width×Length×Height (inch)	ABS	PC / ABS	PC	Steel mounting plate 1.6mm	Plastic mounting plate 3~4.5mm	M1	M2
		G:Grey Cover,T:Transparent Cover	G:Grey Cover,T:Transparent Cover	G:Grey Cover,T:Transparent Cover				
80×110×70	3.15×4.33×2.76	BC-A□S-081107-K	BC-P□S-081107-K	BC-C□S-081107-K				
80×110×85	3.15×4.33×3.35	BC-A□S-081108-K	BC-P□S-081108-K	BC-C□S-081108-K				
80×130×70	3.15×5.12×2.76	BC-A□S-081307-K	BC-P□S-081307-K	BC-C□S-081307-K				
80×130×85	3.15×5.12×3.35	BC-A□S-081308-K	BC-P□S-081308-K	BC-C□S-081308-K				
80×180×70	3.15×7.09×2.76	BC-A□S-081807-K	BC-P□S-081807-K	BC-C□S-081807-K				
80×180×85	3.15×7.09×3.35	BC-A□S-081808-K	BC-P□S-081808-K	BC-C□S-081808-K				
80×250×70	3.15×9.84×2.76	BC-A□S-082507-K	BC-P□S-082507-K	BC-C□S-082507-K				
80×250×85	3.15×9.84×3.35	BC-A□S-082508-K	BC-P□S-082508-K	BC-C□S-082508-K				
125×175×75	4.92×6.89×2.95	BC-A□S-121707-K	BC-P□S-121707-K	BC-C□S-121707-K	1217 S	1217 P	101	156
125×175×100	4.92×6.89×3.94	BC-A□S-121710-K	BC-P□S-121710-K	BC-C□S-121710-K	1217 S	1217 P	101	156

플라스틱 푸시버튼 박스

Plastic Push Button Box



BOXCO PUSH BUTTON PLASTIC BOX



Dimension (허용오차 ±1mm)

PUSH BUTTON HOLE

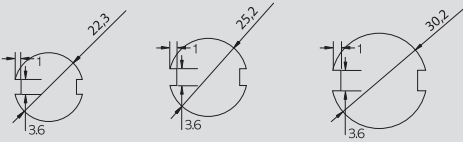

PUSH BUTTON HOLE SPACING

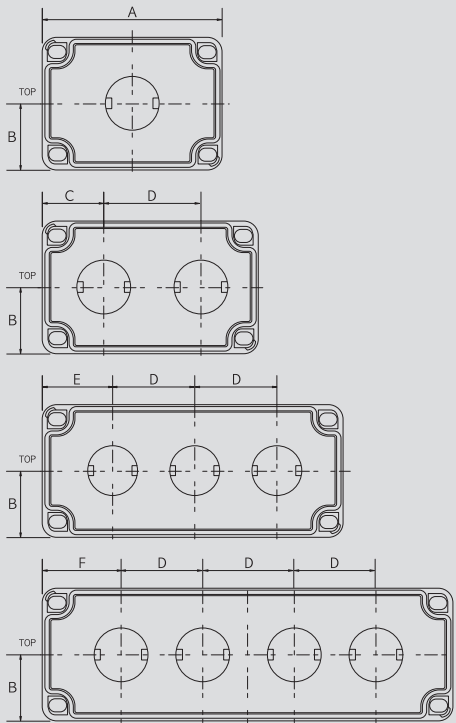

Cat. No.	Division	Hole	Dimension					
			A	B	C	D	E	F
BC-□GS-08110□-□□01	1-Hole	1-Hole	55	40				
BC-□GS-08130□-□□02	2-Hole	2-Hole	-	40	40	50		
BC-□GS-08180□-□□03	3-Hole	3-Hole	-	40		50	40	
BC-□GS-08250□-□□04	4-Hole	4-Hole	-	40		50		50

모델규격 Model and size

φ	Hole	Model	Width×Length×Height (Unit: mm)	Width×Length×Height (Unit: inch)
22 φ	1 HOLE	BC-□GS-081107-2201	80 × 110 × 70	3.15 × 4.33 × 2.76
		BC-□GS-081108-2201	80 × 110 × 85	3.15 × 4.33 × 3.35
	2 HOLE	BC-□GS-081307-2202	80 × 130 × 70	3.15 × 5.12 × 2.76
		BC-□GS-081308-2202	80 × 130 × 85	3.15 × 5.12 × 3.35
	3 HOLE	BC-□GS-081807-2203	80 × 180 × 70	3.15 × 7.09 × 2.76
		BC-□GS-081808-2203	80 × 180 × 85	3.15 × 7.09 × 3.35
	4 HOLE	BC-□GS-082507-2204	80 × 250 × 70	3.15 × 9.84 × 2.76
		BC-□GS-082508-2204	80 × 250 × 85	3.15 × 9.84 × 3.35
25 φ	1 HOLE	BC-□GS-081107-2501	80 × 110 × 70	3.15 × 4.33 × 2.76
		BC-□GS-081108-2501	80 × 110 × 85	3.15 × 4.33 × 3.35
	2 HOLE	BC-□GS-081307-2502	80 × 130 × 70	3.15 × 5.12 × 2.76
		BC-□GS-081308-2502	80 × 130 × 85	3.15 × 5.12 × 3.35
	3 HOLE	BC-□GS-081807-2503	80 × 180 × 70	3.15 × 7.09 × 2.76
		BC-□GS-081808-2503	80 × 180 × 85	3.15 × 7.09 × 3.35
	4 HOLE	BC-□GS-082507-2504	80 × 250 × 70	3.15 × 9.84 × 2.76
		BC-□GS-082508-2504	80 × 250 × 85	3.15 × 9.84 × 3.35
30 φ	1 HOLE	BC-□GS-081107-3001	80 × 110 × 70	3.15 × 4.33 × 2.76
		BC-□GS-081108-3001	80 × 110 × 85	3.15 × 4.33 × 3.35
	2 HOLE	BC-□GS-081307-3002	80 × 130 × 70	3.15 × 5.12 × 2.76
		BC-□GS-081308-3002	80 × 130 × 85	3.15 × 5.12 × 3.35
	3 HOLE	BC-□GS-081807-3003	80 × 180 × 70	3.15 × 7.09 × 2.76
		BC-□GS-081808-3003	80 × 180 × 85	3.15 × 7.09 × 3.35
	4 HOLE	BC-□GS-082507-3004	80 × 250 × 70	3.15 × 9.84 × 2.76
		BC-□GS-082508-3004	80 × 250 × 85	3.15 × 9.84 × 3.35

*A = ABS, P = PC/ABS, C = PC

방수, 방진 보호등급	IP 66/67, IK 07/08
온도영역	ABS : -40~+85 PC : -40~+120
단위	ABS : 94-HB PC : 94-HB, 94-V-0~5VA

알루미늄 푸쉬버튼 박스

Aluminium Push Button Box

BOXCO PUSH BUTTON ALUMINIUM BOX



Dimension (허용오차 ±1mm)

PUSH BUTTON HOLE

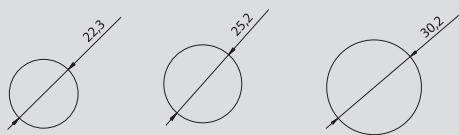

PUSH BUTTON HOLE SPACING

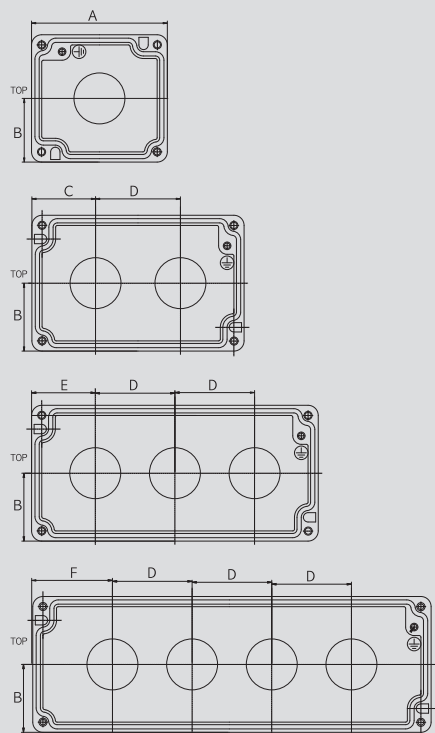

Cat. No.	Division	Hole	A	B	C	D	E	F
BC-AL-08080□-□□01		1-Hole	40	37.5				
BC-AL-08130□-□□02		2-Hole	-	40	38	50		
BC-AL-08180□-□□03		3-Hole	-	40		50	38	
BC-AL-08250□-□□04		4-Hole	-	40		50		50

모델규격 Model and size

φ	Hole	Model	Width×Length×Height (Unit: mm)	Width×Length×Height (Unit: inch)
22 φ	1 HOLE	BC-AL-080806-2201	80 × 75 × 57	3.14 × 2.95 × 2.24
		BC-AL-080807-2201	80 × 75 × 70	3.14 × 2.95 × 2.75
	2 HOLE	BC-AL-081306-2202	80 × 125 × 57	3.14 × 4.92 × 2.24
		BC-AL-081307-2202	80 × 125 × 70	3.14 × 4.92 × 2.75
	3 HOLE	BC-AL-081806-2203	80 × 175 × 57	3.14 × 6.88 × 2.24
		BC-AL-081807-2203	80 × 175 × 70	3.14 × 6.88 × 2.75
	4 HOLE	BC-AL-082506-2204	80 × 250 × 57	3.14 × 9.84 × 2.24
		BC-AL-082507-2204	80 × 250 × 70	3.14 × 9.84 × 2.75
25 φ	1 HOLE	BC-AL-080806-2501	80 × 75 × 57	3.14 × 2.95 × 2.24
		BC-AL-080807-2501	80 × 75 × 70	3.14 × 2.95 × 2.75
	2 HOLE	BC-AL-081306-2502	80 × 125 × 57	3.14 × 4.92 × 2.24
		BC-AL-081307-2502	80 × 125 × 70	3.14 × 4.92 × 2.75
	3 HOLE	BC-AL-081806-2503	80 × 175 × 57	3.14 × 6.88 × 2.24
		BC-AL-081807-2503	80 × 175 × 70	3.14 × 6.88 × 2.75
	4 HOLE	BC-AL-082506-2504	80 × 250 × 57	3.14 × 9.84 × 2.24
		BC-AL-082507-2504	80 × 250 × 70	3.14 × 9.84 × 2.75
30 φ	1 HOLE	BC-AL-080806-3001	80 × 75 × 57	3.14 × 2.95 × 2.24
		BC-AL-080807-3001	80 × 75 × 70	3.14 × 2.95 × 2.75
	2 HOLE	BC-AL-081306-3002	80 × 125 × 57	3.14 × 4.92 × 2.24
		BC-AL-081307-3002	80 × 125 × 70	3.14 × 4.92 × 2.75
	3 HOLE	BC-AL-081806-3003	80 × 175 × 57	3.14 × 6.88 × 2.24
		BC-AL-081807-3003	80 × 175 × 70	3.14 × 6.88 × 2.75
	4 HOLE	BC-AL-082506-3004	80 × 250 × 57	3.14 × 9.84 × 2.24
		BC-AL-082507-3004	80 × 250 × 70	3.14 × 9.84 × 2.75

단자박스

Terminal block box



4P



BASE

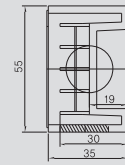
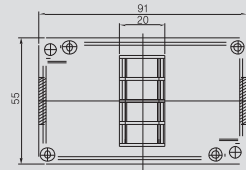

COVER

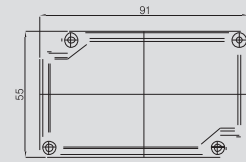

모델규격 Model and size

Model and size		제품모델 Product model					
Width×Length×Height×Hole (Unit : mm커버포함)	Width×Length×Height×Hole (Unit : inch)	ABS 회색 (Grey)		ABS 청회색 (Grayish blue)		PC/ABS 회색 (Grey)	
		불투명 (Opaque)	투명 (Transparent)	불투명 (Opaque)	투명 (Transparent)	불투명 (Opaque)	투명 (Transparent)
55x91x43x21 (Knock out)	2.17×3.58×1.69	BC-AGG-4P	BC-ATG-4P	BC-ABB-4P	BC-ATB-4P	BC-PGG-4P	BC-PTG-4P
방수방진 보호등급	IP 66/67	충격테스트				IK 07/08	
온도영역	ABS : -40~+85 PC : -40~+120						
난연성	PC/ABS : V-0~5VA ABS : 94-V-0						
절연정격전압	400V	충동정격전압				4KV	
정격전류용량	0.75mm sq. - 1.5mm sq.						

4PH



BASE

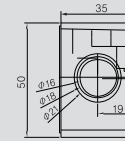
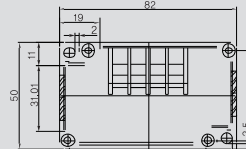

COVER

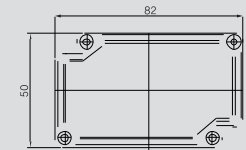

모델규격 Model and size

Model and size		제품모델 Product model					
Width×Length×Height×Hole (Unit : mm커버포함)	Width×Length×Height×Hole (Unit : inch)	ABS 회색 (Grey)		ABS 청회색 (Grayish blue)		PC/ABS 회색 (Grey)	
		불투명 (Opaque)	투명 (Transparent)	불투명 (Opaque)	투명 (Transparent)	불투명 (Opaque)	투명 (Transparent)
50x82x43x21 (Knock out)	1.97×3.23×1.69	BC-AGG-4PH	BC-ATG-4PH	BC-ABB-4PH	BC-ATB-4PH	BC-PGG-4PH	BC-PTG-4PH
방수방진 보호등급	IP 66/67	충격테스트				IK 07/08	
온도영역	ABS : -40~+85 PC : -40~+120						
난연성	PC/ABS : V-0~5VA ABS : 94-V-0						
절연정격전압	400V	충동정격전압				4KV	
정격전류용량	0.75mm sq. - 1.5mm sq.						

단자박스

Terminal block box

4PT



BASE

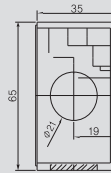
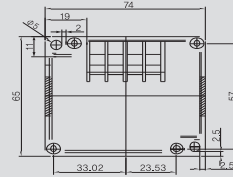

COVER

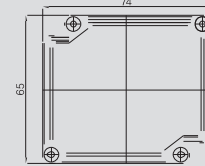

모델규격 Model and size

Model and size		제품모델 Product model					
Width×Length×Height×Hole (Unit : mm커버포함)	Width×Length×Height×Hole (Unit : inch)	ABS 회색 (Grey)		ABS 청회색 (Grayish blue)		PC/ABS 회색 (Grey)	
		불투명 (Opaque)	투명 (Transparent)	불투명 (Opaque)	투명 (Transparent)	불투명 (Opaque)	투명 (Transparent)
65x74x43x21 (Knock out)	2.56×2.91×1.69	BC-AGG-4PT	BC-ATG-4PT	BC-ABB-4PT	BC-ATB-4PT	BC-PGG-4PT	BC-PTG-4PT
방수,방진 보호등급	IP 66/67	충격테스트				IK 07/08	
온도영역	ABS : -40~+85 PC : -40~+120						
난연성	PC/ABS : V-0~5VA ABS : 94-V-0						
절연정격전압	400V	충동정격전압				4KV	
정격전류용량	0.75mm sq. - 1.5mm sq.						

6P



BASE

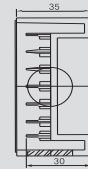
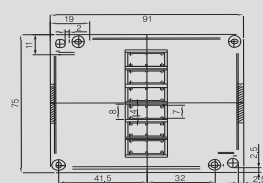

COVER

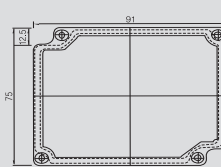

모델규격 Model and size

Model and size		제품모델 Product model					
Width×Length×Height×Hole (Unit : mm커버포함)	Width×Length×Height×Hole (Unit : inch)	ABS 회색 (Grey)		ABS 청회색 (Grayish blue)		PC/ABS 회색 (Grey)	
		불투명 (Opaque)	투명 (Transparent)	불투명 (Opaque)	투명 (Transparent)	불투명 (Opaque)	투명 (Transparent)
75x91x43x21 (Knock out)	2.95×3.58×1.69	BC-AGG-6P	BC-ATG-6P	BC-ABB-6P	BC-ATB-6P	BC-PGG-6P	BC-PTG-6P
방수,방진 보호등급	IP 66/67	충격테스트				IK 07/08	
온도영역	ABS : -40~+85 PC : -40~+120						
난연성	PC/ABS : V-0~5VA ABS : 94-V-0						
절연정격전압	400V	충동정격전압				4KV	
정격전류용량	0.75mm sq. - 1.5mm sq.						

6PH

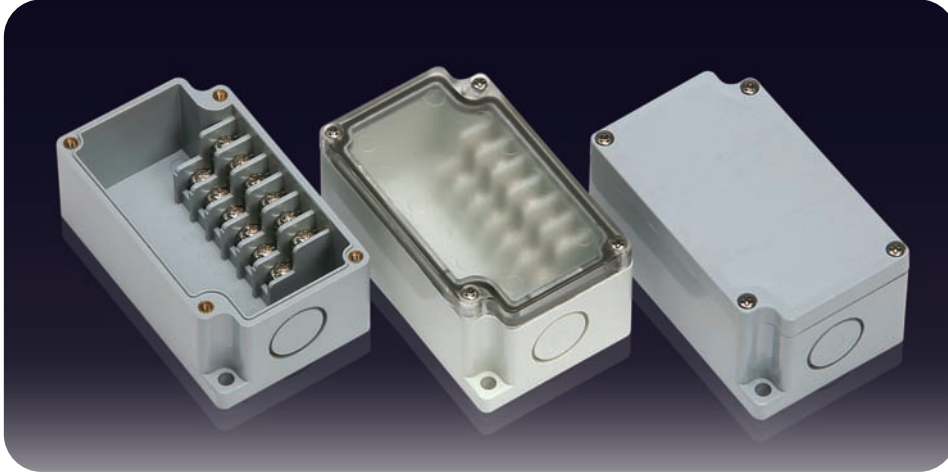

BASE

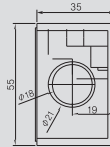
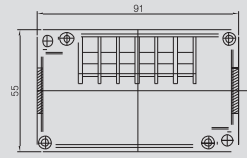

COVER

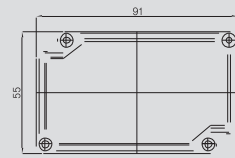

모델규격 Model and size

Model and size		제품모델 Product model					
Width×Length×Height×Hole (Unit : mm커버포함)	Width×Length×Height×Hole (Unit : inch)	ABS 회색 (Grey)		ABS 청회색 (Grayish blue)		PC/ABS 회색 (Grey)	
		불투명 (Opaque)	투명 (Transparent)	불투명 (Opaque)	투명 (Transparent)	불투명 (Opaque)	투명 (Transparent)
55x91x43x21 (Knock out)	2.17×3.58×1.69	BC-AGG-6PH	BC-ATG-6PH	BC-ABB-6PH	BC-ATB-6PH	BC-PGG-6PH	BC-PTG-6PH
방수방진 보호등급	IP 66/67	충격테스트				IK 07/08	
온도영역	ABS : -40~+85 PC : -40~+120						
난연성	PC/ABS : V-0~5VA ABS : 94-V-0						
절연정격전압	400V	충동정격전압				4KV	
정격전류용량	0.75mm sq. - 1.5mm sq.						

6PT



BASE

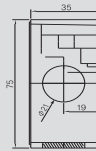
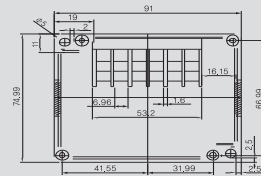

COVER

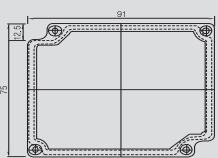

모델규격 Model and size

Model and size		제품모델 Product model					
Width×Length×Height×Hole (Unit : mm커버포함)	Width×Length×Height×Hole (Unit : inch)	ABS 회색 (Grey)		ABS 청회색 (Grayish blue)		PC/ABS 회색 (Grey)	
		불투명 (Opaque)	투명 (Transparent)	불투명 (Opaque)	투명 (Transparent)	불투명 (Opaque)	투명 (Transparent)
75×91×43×21 녹아웃	2.95×3.58×1.69	BC-AGG-6PT	BC-ATG-6PT	BC-ABB-6PT	BC-ATB-6PT	BC-PGG-6PT	BC-PTG-6PT
방수방진 보호등급	IP 66/67	충격테스트				IK 07/08	
온도영역	ABS : -40~+85 PC : -40~+120						
난연성	PC/ABS : V-0~5VA ABS : 94-V-0						
절연정격전압	400V	충동정격전압				4KV	
정격전류용량	0.75mm sq. - 1.5mm sq.						

단자박스

Terminal block box

10P

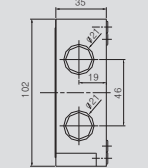
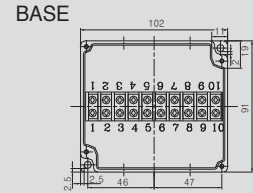
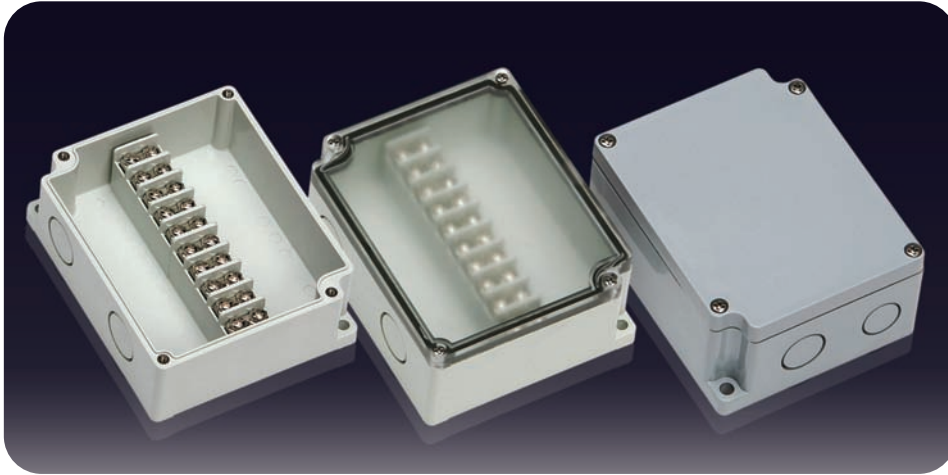

COVER

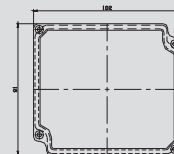

모델규격 Model and size

Model and size		제품모델 Product model					
Width×Length×Height×Hole (Unit : mm커버포함)	Width×Length×Height×Hole (Unit : inch)	ABS 회색 (Grey)		ABS 청회색 (Grayish blue)		PC/ABS 회색 (Grey)	
		불투명 (Opaque)	투명 (Transparent)	불투명 (Opaque)	투명 (Transparent)	불투명 (Opaque)	투명 (Transparent)
102×91×43×21 녹아웃	4.01×3.58×1.69	BC-AGG-10P	BC-ATG-10P	BC-ABB-10P	BC-ATB-10P	BC-PCG-10P	BC-PTG-10P
방수,방진 보호등급	IP 66/67	충격테스트				IK 07/08	
온도영역	ABS : -40~+85 PC : -40~+120						
난연성	PC/ABS : V-0~5VA ABS : 94-V-0						
절연정격전압	400V	충동정격전압				4KV	
정격전류용량	0.75mm sq. - 1.5mm sq.						

10PT

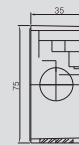
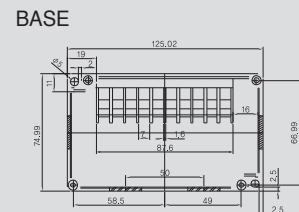
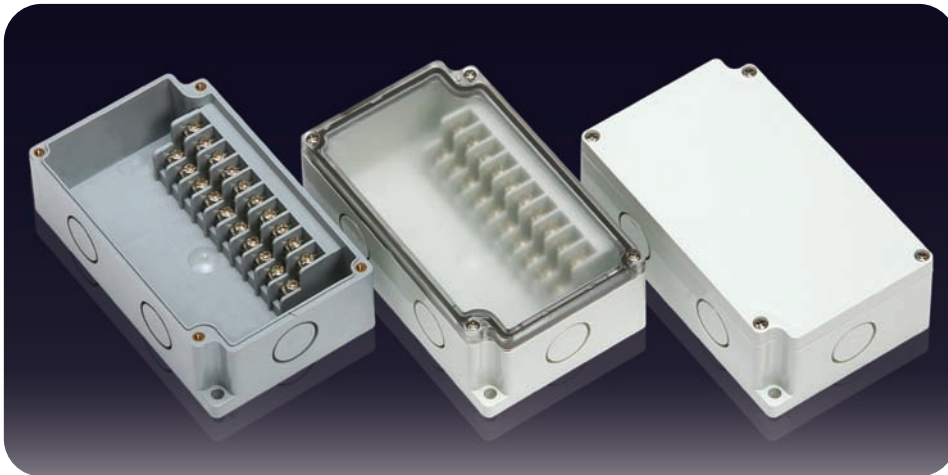

COVER

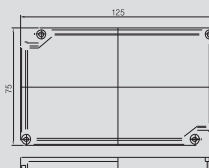

모델규격 Model and size

Model and size		제품모델 Product model					
Width×Length×Height×Hole (Unit : mm커버포함)	Width×Length×Height×Hole (Unit : inch)	ABS 회색 (Grey)		ABS 청회색 (Grayish blue)		PC/ABS 회색 (Grey)	
		불투명 (Opaque)	투명 (Transparent)	불투명 (Opaque)	투명 (Transparent)	불투명 (Opaque)	투명 (Transparent)
75×125×43×21 녹아웃	2.95×4.92×1.69	BC-AGG-10PT	BC-ATG-10PT	BC-ABB-10PT	BC-ATB-10PT	BC-PCG-10PT	BC-PTG-10PT
방수,방진 보호등급	IP 66/67	충격테스트				IK 07/08	
온도영역	ABS : -40~+85 PC : -40~+120						
난연성	PC/ABS : V-0~5VA ABS : 94-V-0						
절연정격전압	400V	충동정격전압				4KV	
정격전류용량	0.75mm sq. - 1.5mm sq.						

15P

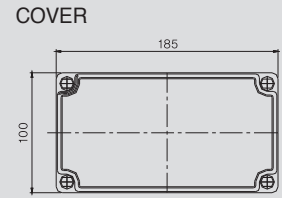
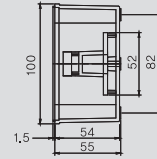
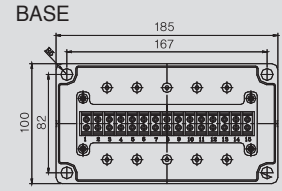
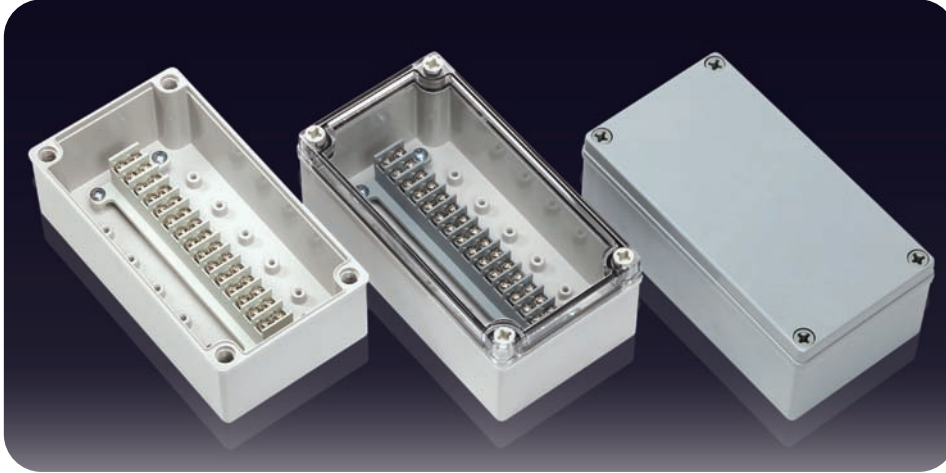

모델규격 Model and size

Model and size		제품모델 Product model					
Width×Length×Height×Hole (Unit : mm커버포함)	Width×Length×Height×Hole (Unit : inch)	ABS 회색 (Grey)		ABS 청회색 (Grayish blue)		PC/ABS 회색 (Grey)	
		불투명 (Opaque)	투명 (Transparent)	불투명 (Opaque)	투명 (Transparent)	불투명 (Opaque)	투명 (Transparent)
100×185×70	3.94×7.28×2.76	BC-AGG-15P	BC-ATG-15P	BC-ABB-15P	BC-ATB-15P	BC-PGG-15P	BC-PTG-15P
방수방진 보호등급	IP 66/67	충격테스트				IK 07/08	
온도영역	ABS : -40~+85 PC : -40~+120						
난연성	PC/ABS : V-0~5VA ABS : 94-V-0						
절연정격전압	400V	충동정격전압				4KV	
정격전류용량	0.75mm sq. - 1.5mm sq.						

15PT

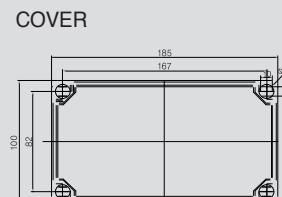
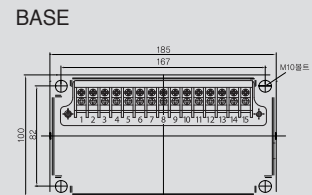

모델규격 Model and size

Model and size		제품모델 Product model					
Width×Length×Height×Hole (Unit : mm커버포함)	Width×Length×Height×Hole (Unit : inch)	ABS 회색 (Grey)		ABS 청회색 (Grayish blue)		PC/ABS 회색 (Grey)	
		불투명 (Opaque)	투명 (Transparent)	불투명 (Opaque)	투명 (Transparent)	불투명 (Opaque)	투명 (Transparent)
100×185×70	3.94×7.28×2.76	BC-AGG-15PT	BC-ATG-15PT	BC-ABB-15PT	BC-ATB-15PT	BC-PGG-15PT	BC-PTG-15PT
방수방진 보호등급	IP 66/67	충격테스트				IK 07/08	
온도영역	ABS : -40~+85 PC : -40~+120						
난연성	PC/ABS : V-0~5VA ABS : 94-V-0						
절연정격전압	400V	충동정격전압				4KV	
정격전류용량	0.75mm sq. - 1.5mm sq.						

단자박스

Terminal block box

20P



BASE

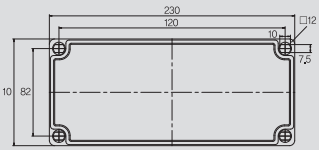

COVER

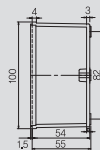
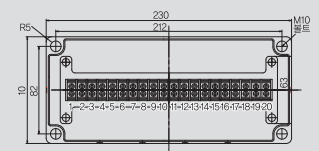

모델규격 Model and size

Model and size		제품모델 Product model					
Width×Length×Height×Hole (Unit : mm커버포함)	Width×Length×Height×Hole (Unit : inch)	ABS 회색 (Grey)		ABS 청회색 (Grayish blue)		PC/ABS 회색 (Grey)	
		불투명 (Opaque)	투명 (Transparent)	불투명 (Opaque)	투명 (Transparent)	불투명 (Opaque)	투명 (Transparent)
100×230×70	3.94×9.06×2.76	BC-AGG-20P	BC-ATG-20P	BC-ABB-20P	BC-ATB-20P	BC-PGG-20P	BC-PTG-20P
방수방진 보호등급	IP 66/67	충격테스트				IK 07/08	
온도영역	ABS : -40~+85 PC : -40~+120						
난연성	PC/ABS : V-0~5VA ABS : 94-V-0						
절연정격전압	400V	충동정격전압				4KV	
정격전류용량	0.75mm sq. - 1.5mm sq.						

20PT



BASE

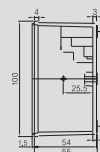
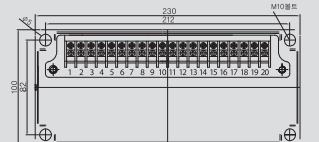

COVER

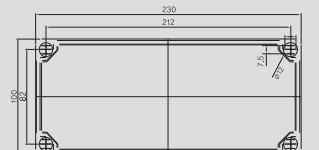

모델규격 Model and size

Model and size		제품모델 Product model					
Width×Length×Height×Hole (Unit : mm커버포함)	Width×Length×Height×Hole (Unit : inch)	ABS 회색 (Grey)		ABS 청회색 (Grayish blue)		PC/ABS 회색 (Grey)	
		불투명 (Opaque)	투명 (Transparent)	불투명 (Opaque)	투명 (Transparent)	불투명 (Opaque)	투명 (Transparent)
100×230×70	3.94×9.06×2.76	BC-AGG-20PT	BC-ATG-20PT	BC-ABB-20PT	BC-ATB-20PT	BC-GG-20PT	BC-PTG-20PT
방수방진 보호등급	IP 66/67	충격테스트				IK 07/08	
온도영역	ABS : -40~+85 PC : -40~+120						
난연성	PC/ABS : V-0~5VA ABS : 94-V-0						
절연정격전압	400V	충동정격전압				4KV	
정격전류용량	0.75mm sq. - 1.5mm sq.						

20PA

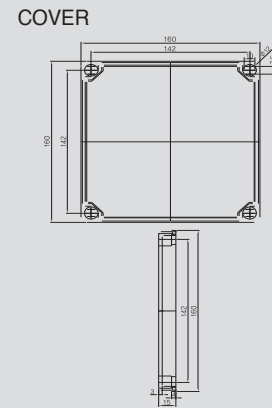
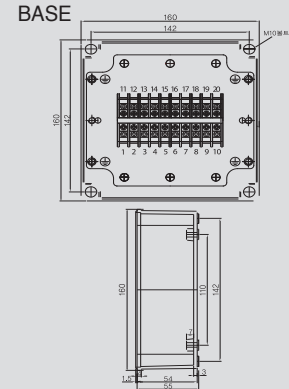

모델규격 Model and size

Model and size		제품모델 Product model					
Width×Length×Height×Hole (Unit : mm커버포함)	Width×Length×Height×Hole (Unit : inch)	ABS 회색 (Grey)		ABS 청회색 (Grayish blue)		PC/ABS 회색 (Grey)	
		불투명 (Opaque)	투명 (Transparent)	불투명 (Opaque)	투명 (Transparent)	불투명 (Opaque)	투명 (Transparent)
160×160×70	6.30×6.30×2.76	BC-AGG-20PA	BC-ATG-20PA	BC-ABB-20PA	BC-ATB-20PA	BC-PGG-20PA	BC-PTG-20PA
방수방진 보호등급	IP 66/67		충격테스트		IK 07/08		
온도영역	ABS : -40~+85 PC : -40~+120						
난연성	PC/ABS : V-0~5VA ABS : 94-V-0						
절연정격전압	400V		충동정격전압		4KV		
정격전류용량	0.75mm sq. - 1.5mm sq.						

20P2

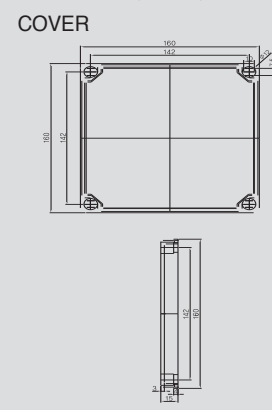
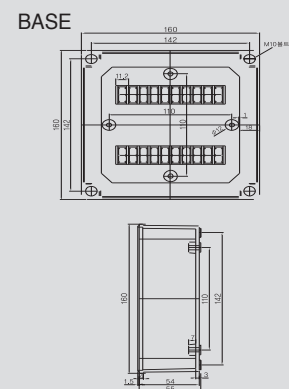
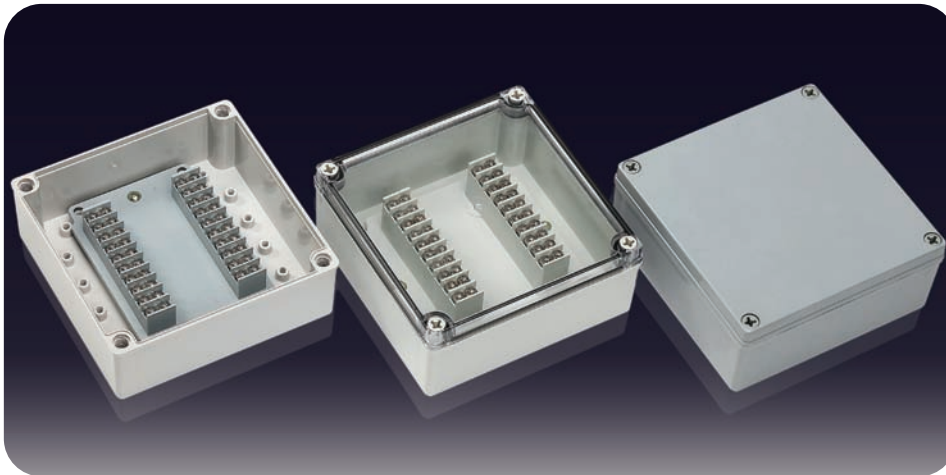

모델규격 Model and size

Model and size		제품모델 Product model					
Width×Length×Height×Hole (Unit : mm커버포함)	Width×Length×Height×Hole (Unit : inch)	ABS 회색 (Grey)		ABS 청회색 (Grayish blue)		PC/ABS 회색 (Grey)	
		불투명 (Opaque)	투명 (Transparent)	불투명 (Opaque)	투명 (Transparent)	불투명 (Opaque)	투명 (Transparent)
160×160×70	6.30×6.30×2.76	BC-AGG-20P-2	BC-ATG-20P-2	BC-ABB-20P-2	BC-ATB-20P-2	BC-PGG-20P-2	BC-PTG-20P-2
방수방진 보호등급	IP 66/67		충격테스트		IK 07/08		
온도영역	ABS : -40~+85 PC : -40~+120						
난연성	PC/ABS : V-0~5VA ABS : 94-V-0						
절연정격전압	400V		충동정격전압		4KV		
정격전류용량	0.75mm sq. - 1.5mm sq.						

단자박스

Terminal block box

PBT-3P

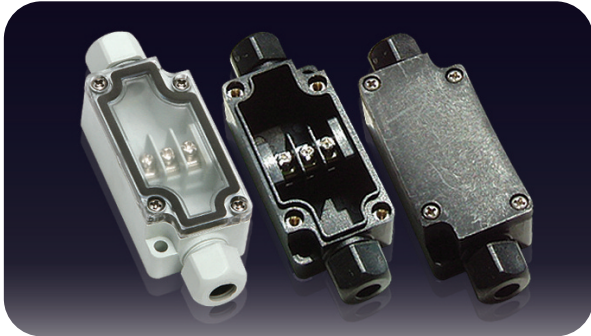

모델규격 Model and size

Model and size		제품모델 Product model			
Width × Length × Height × Hole (Unit : mm)	Width × Length × Height × Hole (Unit : inch)	PBT 회색 (Grey)		PBT 검정색 (Black)	
		Grey	Transparent	Black	Transparent
33 × 65 × 24 × 9.2	1.29 × 2.55 × 0.94 × 0.36	BC-TGG-3PC	BC-TTG-3PC	BC-TBB-3PC	BC-TTB-3PC
온도영역	PBT : -40~+100				
난연성	PBT+GF15%, V-0				

Dimension (허용오차 ±1mm)

BASE

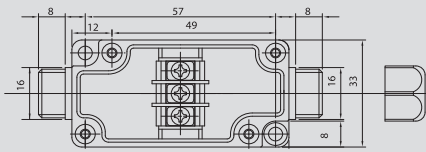

SIDE

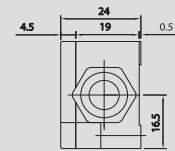

PBT-4P



모델규격 Model and size

Model and size		제품모델 Product model			
Width × Length × Height × Hole (Unit : mm)	Width × Length × Height × Hole (Unit : inch)	PBT 회색 (Grey)		PBT 검정색 (Black)	
		Grey	Transparent	Black	Transparent
40 × 60 × 24 × 9.2	1.57 × 2.36 × 0.94 × 0.36	BC-TGG-4PC	BC-TTG-4PC	BC-TBB-4PC	BC-TTB-4PC
온도영역	PBT : -40~+100				
난연성	PBT+GF15%, V-0				

Dimension (허용오차 ±1mm)

BASE

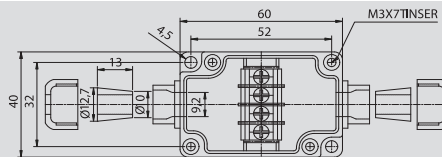

SIDE

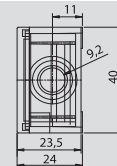

PBT-6P



모델규격 Model and size

Model and size		제품모델 Product model			
Width × Length × Height × Hole (Unit : mm)	Width × Length × Height × Hole (Unit : inch)	PBT 회색 (Grey)		PBT 검정색 (Black)	
		Grey	Transparent	Black	Transparent
50 × 70 × 24 × 9.2	1.96 × 2.75 × 0.94 × 0.36	BC-TGG-6PC	BC-TTG-6PC	BC-TBB-6PC	BC-TTB-6PC
온도영역	PBT : -40~+100				
난연성	PBT+GF15%, V-0				

Dimension (허용오차 ±1mm)

BASE

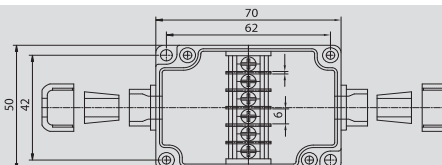

SIDE

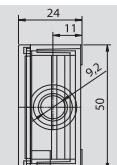

알루미늄 박스

Aluminium box



ALUMINIUM BOX



Dimension (허용오차 ±1mm)

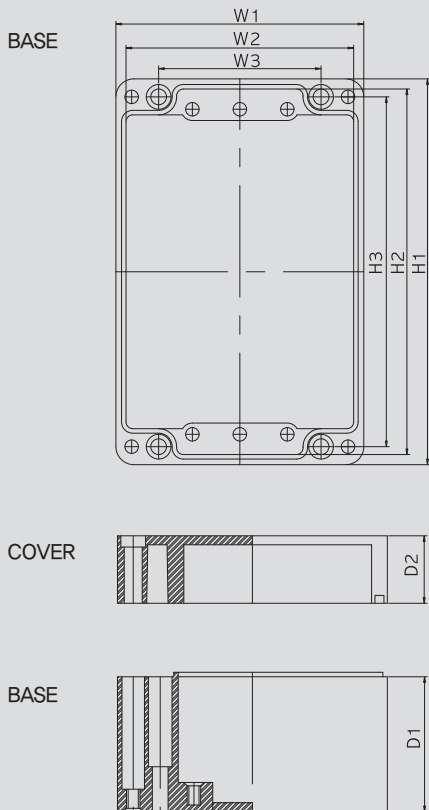

모델규격 Model and size

Model and size (cover included)			속판모델 Plate Model
Width×Length×Height (Unit : mm)	Width×Length×Height (Unit : inch)	Model	철속판 Steel mounting plate
45 × 50 × 32	1.77 × 1.96 × 1.25	BC-AL-050503	
64 × 58 × 34	2.51 × 2.28 × 1.33	BC-AL-060603	
64 × 58 × 46	2.51 × 2.28 × 1.81	BC-AL-060605	
64 × 98 × 34	2.51 × 3.85 × 1.33	BC-AL-061003	
64 × 98 × 46	2.51 × 3.85 × 1.81	BC-AL-061005	
64 × 150 × 34	2.51 × 5.90 × 1.33	BC-AL-061503	
64 × 150 × 46	2.51 × 5.90 × 1.81	BC-AL-061505	
80 × 75 × 57	3.14 × 2.95 × 2.24	BC-AL-080806	0808A
80 × 75 × 70	3.14 × 2.95 × 2.75	BC-AL-080807	0808A
80 × 125 × 57	3.14 × 4.92 × 2.24	BC-AL-081306	0813A
80 × 125 × 70	3.14 × 4.92 × 2.75	BC-AL-081307	0813A
80 × 175 × 57	3.14 × 6.88 × 2.24	BC-AL-081806	0818A
80 × 175 × 70	3.14 × 6.88 × 2.75	BC-AL-081807	0818A
80 × 250 × 57	3.14 × 9.84 × 2.24	BC-AL-082506	0825A
80 × 250 × 70	3.14 × 9.84 × 2.75	BC-AL-082507	0825A
100 × 100 × 81	3.93 × 3.93 × 3.18	BC-AL-101008	1010A
100 × 160 × 81	3.93 × 6.29 × 3.18	BC-AL-101608	1016A
120 × 122 × 81	4.72 × 4.80 × 3.18	BC-AL-121208	1212A
120 × 220 × 81	4.72 × 8.66 × 3.18	BC-AL-122208	1222A
120 × 220 × 91	4.72 × 8.66 × 3.58	BC-AL-122209	1222A
120 × 360 × 81	4.72 × 14.17 × 3.18	BC-AL-123608	1236A
150 × 132 × 90	5.90 × 5.19 × 3.54	BC-AL-151309	1513A
160 × 160 × 91	6.29 × 6.29 × 3.58	BC-AL-161609	1616A
160 × 210 × 100	6.29 × 8.26 × 3.93	BC-AL-162110	1621A
160 × 260 × 91	6.29 × 10.23 × 3.58	BC-AL-162609	1626A
160 × 360 × 91	6.29 × 14.17 × 3.58	BC-AL-163609	1636A
180 × 180 × 101	7.08 × 7.08 × 3.97	BC-AL-181810	1818A
230 × 200 × 111	9.05 × 7.87 × 4.37	BC-AL-232011	2320A
230 × 200 × 180	9.05 × 7.87 × 7.08	BC-AL-232018	2320A
230 × 280 × 111	9.05 × 11.02 × 4.37	BC-AL-232811	2328A
230 × 330 × 111	9.05 × 12.99 × 4.37	BC-AL-233311	2333A
313 × 404 × 111	12.32 × 15.90 × 4.37	BC-AL-314011	3140A
313 × 404 × 181	12.32 × 15.90 × 7.12	BC-AL-314018	3140A

방수,방진 보호등급 IP 66/67, IK 09/10

알루미늄 단자박스

Aluminium Terminal block box

제품특징 Product characteristics

1. 화학물질에 대한 높은 내성을 가지고 있습니다.
 2. 넓은 온도 영역에 사용 가능합니다.
 3. 옥내용, 옥외용, 연근해 지역 등 해수의 접촉이 예상되는 유해환경에 적합합니다.
1. It has excellent resistance against chemicals.
 2. It can be used in wide temperature range.
 3. It is proper to be used for indoor, outdoor or coastal area in harmful environment where expected to be contact with sea water.



모델규격 Model and size

Model	Width×Length×Height (Unit : mm)	Width×Length×Height (Unit : inch)
BC-AL-5PT	80×75×57	3.15×2.95×2.24

Dimension (허용오차 allowance ±1mm)

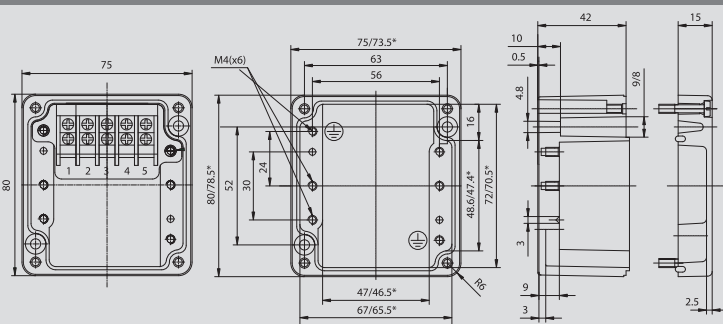

방수,방진 보호등급 IP 66/67, IK 09/10



모델규격 Model and size

Model	Width×Length×Height (Unit : mm)	Width×Length×Height (Unit : inch)
BC-AL-6P	80×75×57	3.15×2.95×2.24

Dimension (허용오차 allowance ±1mm)

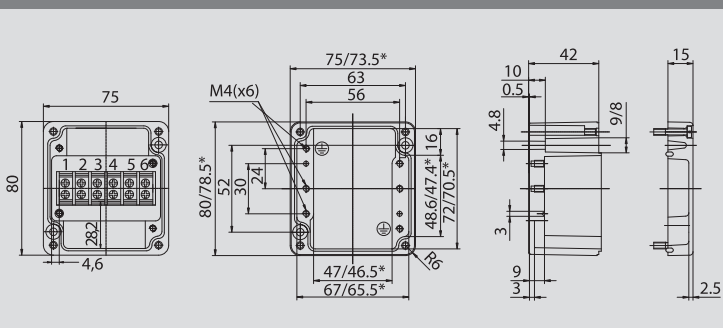

방수,방진 보호등급 IP 66/67, IK 09/10



모델규격 Model and size

Model	Width×Length×Height (Unit : mm)	Width×Length×Height (Unit : inch)
BC-AL-9P	100×100×80	3.94×3.94×3.15

Dimension (허용오차 allowance ±1mm)

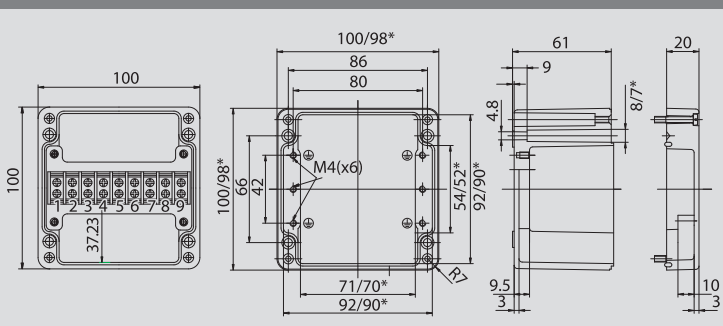

방수,방진 보호등급 IP 66/67, IK 09/10



모델규격 Model and size

Model	Width×Length×Height (Unit :mm)	Width×Length×Height (Unit : inch)
BC-AL-10PT	80 × 125 × 57	3.15 × 6.89 × 2.24

Dimension (허용오차 allowance ±1mm)

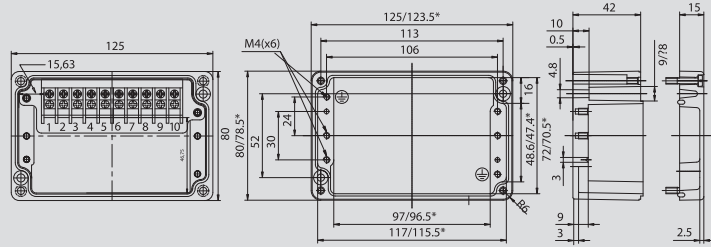

방수,방진 보호등급 IP 66/67, IK 09/10



모델규격 Model and size

Model	Width×Length×Height (Unit :mm)	Width×Length×Height (Unit : inch)
BC-AL-15PT	100 × 160 × 80	3.94 × 7.87 × 3.15

Dimension (허용오차 allowance ±1mm)

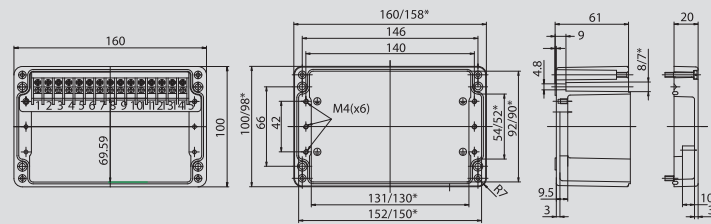

방수,방진 보호등급 IP 66/67, IK 09/10



모델규격 Model and size

Model	Width×Length×Height (Unit :mm)	Width×Length×Height (Unit : inch)
BC-AL-15P	100 × 160 × 80	3.94 × 7.87 × 3.15

Dimension (허용오차 allowance ±1mm)

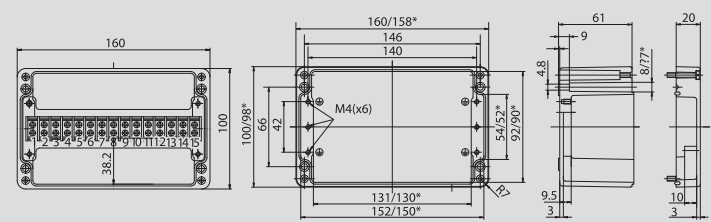

방수,방진 보호등급 IP 66/67, IK 09/10



모델규격 Model and size

Model	Width×Length×Height (Unit :mm)	Width×Length×Height (Unit : inch)
BC-AL-20P-T	120 × 220 × 80	4.72 × 8.66 × 3.15

Dimension (허용오차 allowance ±1mm)

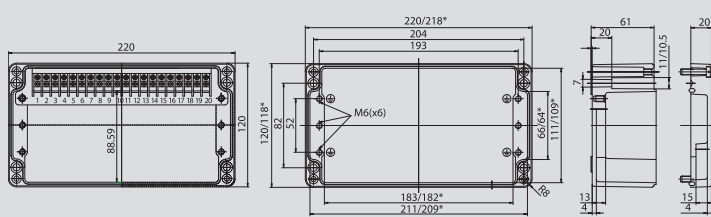

방수,방진 보호등급 IP 66/67, IK 09/10

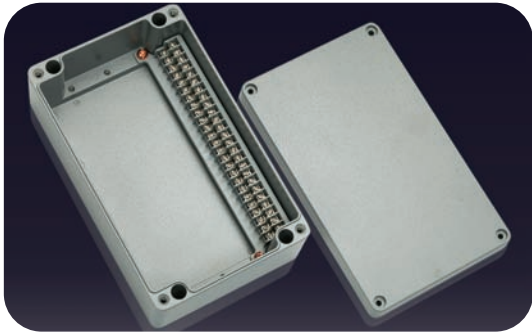

모델규격 Model and size

Model	Width×Length×Height (Unit :mm)	Width×Length×Height (Unit : inch)
BC-AL-25PT	160×260×90	6.30×10.24×3.54

Dimension (허용오차 allowance ±1mm)

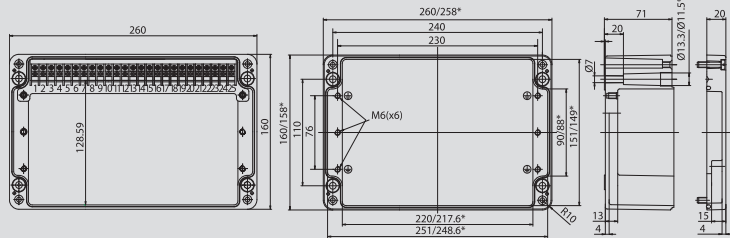

방수,방진 보호등급 IP 66/67, IK 09/10



모델규격 Model and size

Model	Width×Length×Height (Unit :mm)	Width×Length×Height (Unit : inch)
BC-AL-30PAS	120×220×80	4.72×8.66×3.15

Dimension (허용오차 allowance ±1mm)

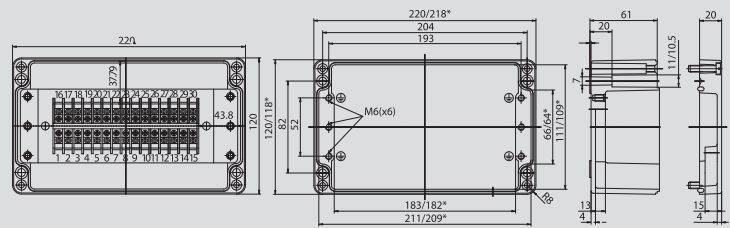

방수,방진 보호등급 IP 66/67, IK 09/10



모델규격 Model and size

Model	Width×Length×Height (Unit :mm)	Width×Length×Height (Unit : inch)
BC-AL-30PA	180×180×100	7.09×7.09×3.94

Dimension (허용오차 allowance ±1mm)

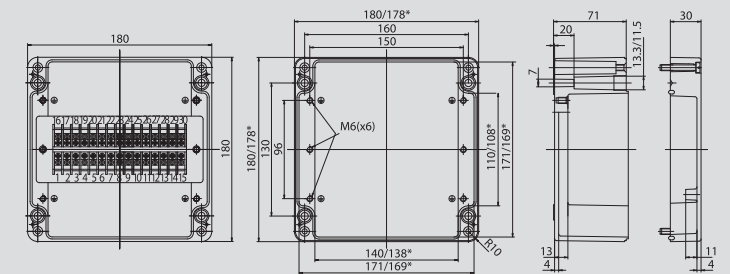

방수,방진 보호등급 IP 66/67, IK 09/10



모델규격 Model and size

Model	Width×Length×Height (Unit :mm)	Width×Length×Height (Unit : inch)
BC-AL-30P2	230×200×110	9.06×7.87×4.33

Dimension (허용오차 allowance ±1mm)

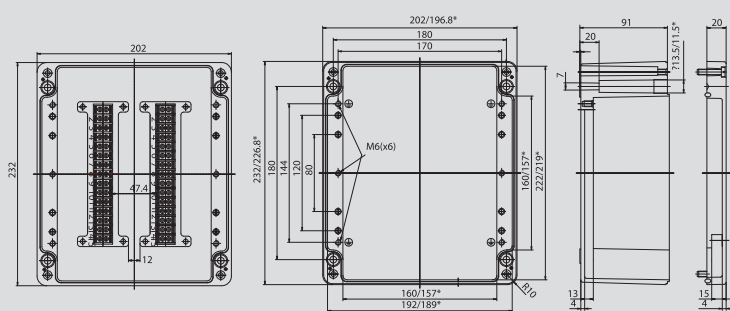

방수,방진 보호등급 IP 66/67, IK 09/10

알루미늄 단자박스

Aluminium Terminal block box



모델규격 Model and size

Model	Width×Length×Height (Unit :mm)	Width×Length×Height (Unit : inch)
BC-AL-40PA	160×260×90	6.30×10.24×3.54

Dimension (허용오차 allowance ±1mm)

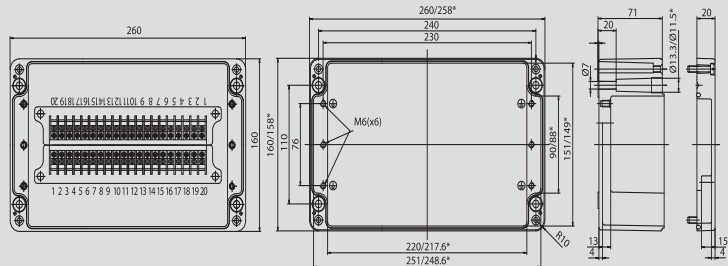

방수,방진 보호등급 IP 66/67, IK 09/10

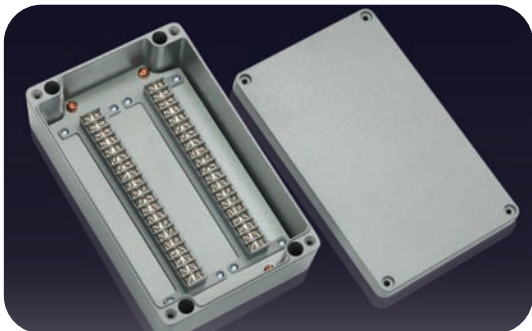

모델규격 Model and size

Model	Width×Length×Height (Unit :mm)	Width×Length×Height (Unit : inch)
BC-AL-40P2	160×260×90	6.30×10.24×3.54

Dimension (허용오차 allowance ±1mm)

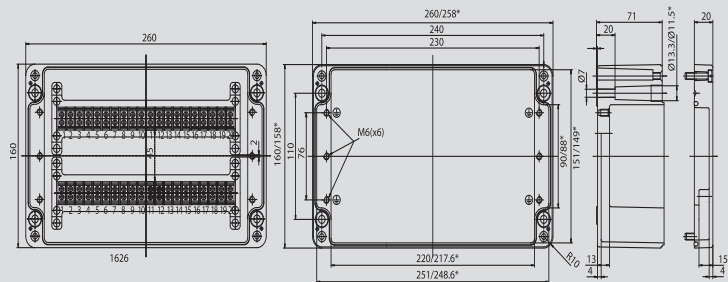

방수,방진 보호등급 IP 66/67, IK 09/10



모델규격 Model and size

Model	Width×Length×Height (Unit :mm)	Width×Length×Height (Unit : inch)
BC-AL-45P3	230×200×110	9.06×7.87×4.33

Dimension (허용오차 allowance ±1mm)

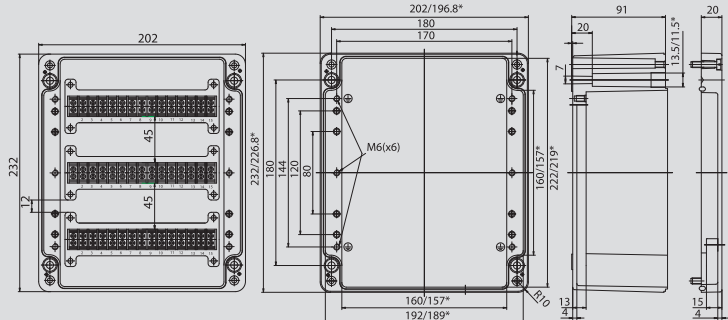

방수,방진 보호등급 IP 66/67, IK 09/10



모델규격 Model and size

Model	Width×Length×Height (Unit :mm)	Width×Length×Height (Unit : inch)
BC-AL-50PA	160×260×90	6.30×10.24×3.54

Dimension (허용오차 allowance ±1mm)

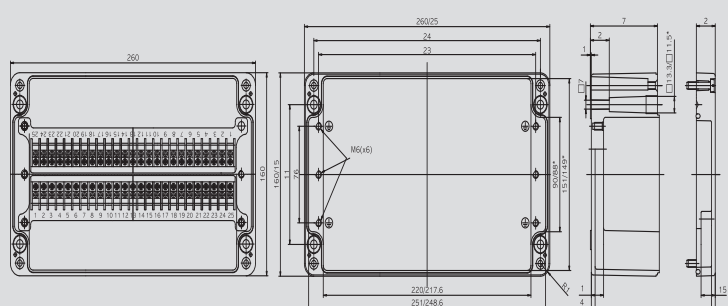

방수,방진 보호등급 IP 66/67, IK 09/10

SMPS CASE

Smps Case



BC-SMPS-162609



설치예 Example



Dimension (허용오차 allowance ±1mm)

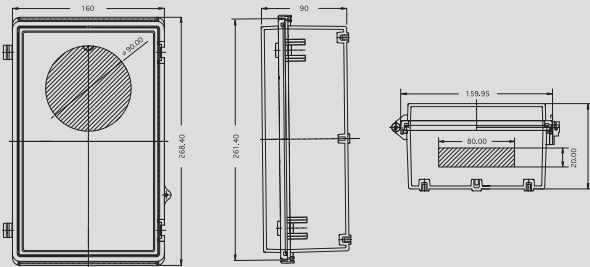

제품특징 Product characteristics

전면에 환기구(Vent)를 부착할 수 있는 홀 가공이 되어 있으며, 하부에 단자대 조립이 쉽도록 사각 커팅이 되어 있습니다.
It has hole for installing vent in front, It is easy to assemble terminal block through cutting rectangle on the bottom.

모델규격 Model and size

Model	Width×Length×Height (Unit: mm)	Width×Length×Height (Unit: inch)
BC-SMPS-162609	160 × 260 × 90	6.30 × 10.24 × 3.54
정격전류용량	50W ~ 200W	

BC-SMPS-192810



설치예 Example



Dimension (허용오차 allowance ±1mm)

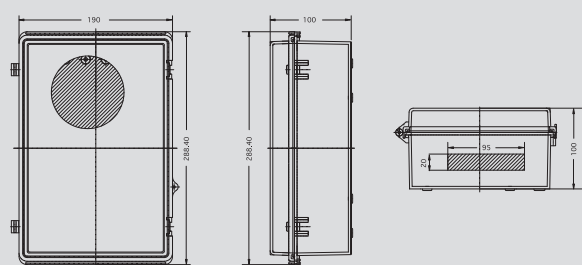

제품특징 Product characteristics

전면에 환기구(Vent)를 부착할 수 있는 홀 가공이 되어 있으며, 하부에 단자대 조립이 쉽도록 사각 커팅이 되어 있습니다.
It has hole for installing vent in front, It is easy to assemble terminal block through cutting rectangle on the bottom.

모델규격 Model and size

Model	Width×Length×Height (Unit: mm)	Width×Length×Height (Unit: inch)
BC-SMPS-192810	190 × 280 × 100	7.48 × 11.00 × 3.94
정격전류용량	150W ~ 350W	

SMPS CASE

Smps Case

BC-SMPS-193813



설치예 Example



Dimension (허용오차 allowance ±1mm)

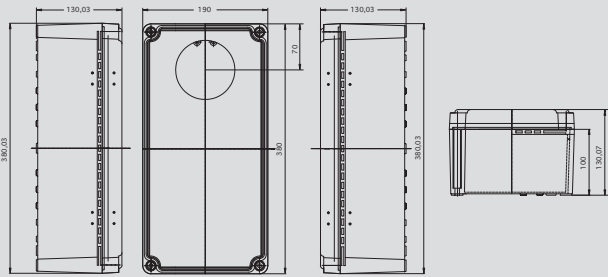

제품특징 Product characteristics

전면에 환기구(Vent)를 부착할 수 있는 홀 가공이 되어 습니다.
It has hole for installing vent in front.

모델규격 Model and size

Model	Width×Length×Height (Unit: mm)	Width×Length×Height (Unit: inch)
BC-SMPS-193813	190 × 380 × 130	7.48 × 14.96 × 5.12
정격전류용량	600W ~ 1,200W	

BC-CONCENT-131508



설치예 Example



제품특징 Product characteristics

상·하부에 21Ø낙아웃(Knock out)이 3개씩 있으며 전선 인입용 U홀이 2개 가공되어 있습니다.
There are three knock out of 21Ø in top and bottom, two U holes for drop wire.

모델규격 Model and size

Model	Width×Length×Height (Unit: mm)	Width×Length×Height (Unit: inch)
BC-CONCENT-131508	135 × 150 × 80	5.3 × 5.91 × 3.15



이중도어

Dual door enclosure



박스코 이중도어 조립도 Assembly of Dual door kits



제품특징 Product characteristics

1. 이중도어는 손잡이와 힌지 방식으로 조립되어 개폐가 용이합니다.
 2. 4개의 지지대로 고정되어 매우 견고하고 내구성을 가지며, 외관이 미려합니다.
1. Dual door is easy to open or close as it will be assembled with handle and hinge type.
 2. It is very strong as it is fixed with 4 supports and it has good external appearance.

모델규격 Model and size

이중도어 적용가능 제품 Swing Frame applicable model		제품모델 Product model		이중도어 적용가능 제품 Swing Frame applicable model		제품모델 Product model	
Size	Model	이중도어 Dual door (테, 지지대, 힌지, 손잡이포함) (Frame, support, hinge, handle included)	이중도어 중판 Dual door mounting plate (Aluminium)	Size	Model	이중도어 Dual door (테, 지지대, 힌지, 손잡이포함) (Frame, support, hinge, handle included)	이중도어 중판 Dual door mounting plate (Aluminium)
Width×Length×Height (mm)				Width×Length×Height (mm)			
200×300×130	BC-□□P-203013	BC-F203013	BC-FA2030	300×400×180	BC-□□P-304018	BC-F304018	BC-FA3040
200×300×150	BC-□□P-203015	BC-F203015	BC-FA2030	350×450×160	BC-□□P-354516	BC-F354516	BC-FA3545
200×300×180	BC-□□P-203018	BC-F203018	BC-FA2030	350×450×200	BC-□□P-354520	BC-F354520	BC-FA3545
250×350×150	BC-□□P-253515	BC-F253515	BC-FA2535	400×500×160	BC-□□P-405016	BC-F405016	BC-FA4050
250×350×180	BC-□□P-253518	BC-F253518	BC-FA2535	400×500×200	BC-□□P-405020	BC-F405020	BC-FA4050
280×280×130	BC-□□P-282813	BC-F282813	BC-FA2828	400×500×200	BC-□□H-405020	BC-F405020	BC-FA4050
280×380×130	BC-□□P-283813	BC-F283813	BC-FA2838	400×600×180	BC-□□P-406018	BC-F406018	BC-FA4060
300×300×150	BC-□□P-303015	BC-F303015	BC-FA3030	400×600×230	BC-□□P-406023	BC-F406023	BC-FA4060
300×300×180	BC-□□P-303018	BC-F303018	BC-FA3030	400×600×230	BC-□□H-406023	BC-F406023	BC-FA4060
300×400×150	BC-□□P-304015	BC-F304015	BC-FA3040	530×630×185	BC-□□P-506018	BC-F506018	BC-FA5060
				530×630×255	BC-□□P-506025	BC-F506025	BC-FA5060

일체형 이중도어

All-in-one-Dual door enclosure



Dimension (허용오차 ±1mm)

COVER

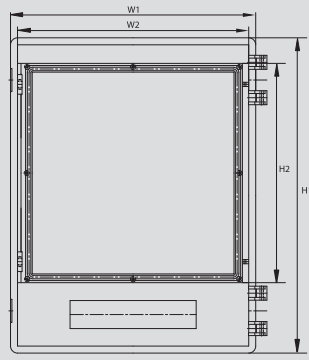

COVER + BASE

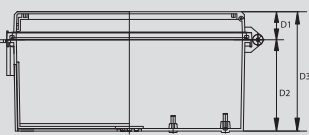

제품특징 Product characteristics

1. 베이스 상, 하부에 지붕(ROOF)이 돌출되어 있어 비나 먼지 등의 침투를 이적으로 완벽하게 차단하는 디자인으로 되어있습니다.
 2. 커버와 베이스의 분리가 용이하여 가공 및 인쇄작업시 사용자가 쉽게 탈부착이 가능토록 제작 하였습니다.
 3. 카바와 투명창 일체형으로 제품가격과 조립비를 획기적으로 낮출수 있습니다.
 4. 제품에 힌지를 일체형으로 성형하였으며, 힌지 연결핀과 매미고리 중요부위를 스테인레스로 제작하여 매우 견고하며 부식이 거의 없습니다.
1. It is designed to prevent the penetration of rain or dust perfectly double as roof is protruded from top and bottom of the base.
 2. It is easy to separate cover and base so that user can attach of detach them for processing and printing.
 3. It is possible to reduce Product price and assembly cost from integrated cover and transparent window
 4. Insert hinge into the product and hinge connecting pin and important parts of draw latch are made of stainless steel so that it is very strong and corrosion resistant.

모델규격 Model and size

Model and size (Cover included)		제품모델 Product model		속판 Mounting Plate		이중도어 Dual door	
Width×Length×Height (mm)	Width×Length×Height (inch)	ABS	PC	Model No.	Size (mm)	Model No.	Size (mm)
250×350×160	9.84×13.77×6.29	BC-AGD-253516	BC-CGD-253516	2535P	2535S	D2535	220×220
250×350×190	9.84×13.77×7.48	BC-AGD-253519	BC-CGD-253519	2535P	2535S	D2535	220×220
350×450×130	13.77×17.11×5.11	BC-AGD-354513	BC-CGD-354513	3545P	3545S	D3545	314×313
350×450×170	13.77×17.11×6.69	BC-AGD-354517	BC-CGD-354517	3545P	3545S	D3545	314×313
350×450×210	13.77×17.11×8.26	BC-AGD-354521	BC-CGD-354521	3545P	3545S	D3545	314×313

박스코 알루미늄 카드 삽입형 하우징

Boxco aluminium housing for inserting card



Dimension (허용오차 ±1mm)

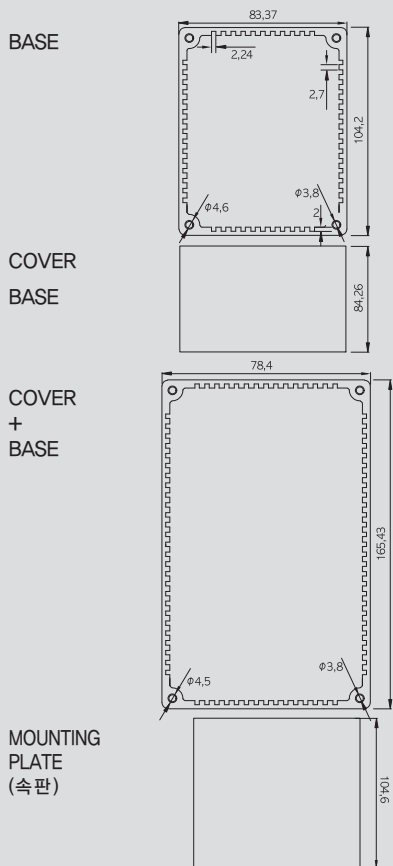

제품특징 Product characteristics

1. PCB 삽입용 가이드 슬롯 내재
 2. 프로파일 길이는 임의로 선택 가능합니다.
 3. 고부식성 환경에 적합한 알루미늄 SBGL.(주문제작)
 4. 전자파 차폐용 EMC버전(주문제작)
1. Built-in guide slot for inserting PCB
 2. Optional extension to length of the profile.
 3. Aluminium SBGL is suitable for highly corrosive enviroment (Custom)
 4. Optional EMC-version for Electromagnetic shielding (Custom)

모델규격 Model and size

Product model	Model and size (cover included)	
	Width × Length × Height (Unit : mm)	Width × Length × Height (Unit : inch)
BC-ALC-111609	111.5 × 166 × 91.5	4.39 × 6.53 × 3.6
BC-ALC-172011	173 × 206 × 113	6.81 × 8.11 × 4.44

조각, 인쇄, 색상서비스

Carving, Printing, Coloring Service

MCT PROCESSING SERVICE

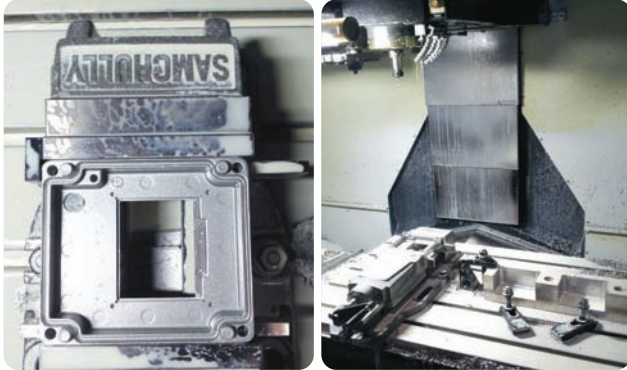

■MCT 가공 서비스 제공

고속절삭이 가능한 최신식 수직형 MCT 보유로 알루미늄 엔클로저의 다양한 가공 및 탭 작업이 정밀하게 이뤄집니다.

■Providing MCT tooling service

Various tooling and tab processing of Aluminium enclosure is accurately providing from MCT vertical drilling machine with high speed cutting.

HOLE PROCESSING SERVICE

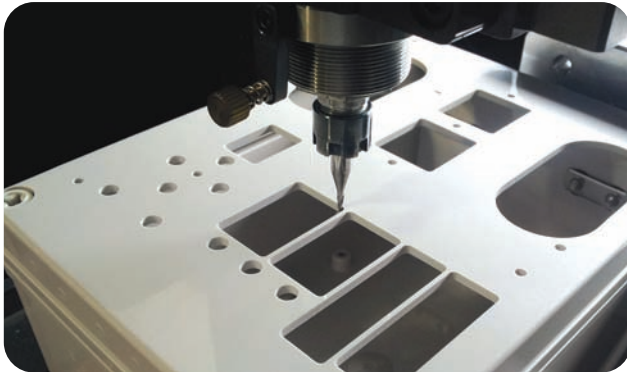

■조각기 가공서비스

박스코는 축적된 경험을 바탕으로 정교한 홀가공 기술로 고객의 다양한 요구에 부응합니다.(측면가공 가능).

■Sculpt processing service

Boxco Inc. meet on customer's variety of request by a sophisticated hole processing technology on the basis of accumulated experience. (can be applied to the side of box)

PRINTING SERVICE



■실크스크린 및 문자조각 서비스

선명하게 인쇄되는 실크스크린과 문자 조각으로 귀사제품을 한층 돋보이게 합니다.

■Silk-screen printing and letter sculpturing service

A vivid silk-screen printing and letter sculpturing service make your product outstanding.

COLORING SERVICE



■색상 서비스

다양한 색상으로 소비자가 원하는 고품질 엔클로저를 생산, 공급하여 드립니다.

■Coloring service

we produce high quality enclosure with a variety of color.

케이블 그랜드

Cable Glands



BC-PG CABLE GLAND



BASE

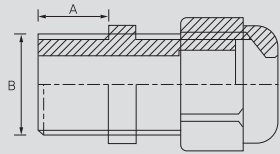

모델규격 Model and size

Article no.	Cable Range (φ mm)	A (mm)	B (mm)
BC-PG7-G	3 ~ 6.5	8	12.5
BC-PG9-G	4 ~ 8	8	15.2
BC-PG11-G	5 ~ 10	9	18.6
BC-PG13.5-G	6 ~ 12	10	20.4
BC-PG16-G	10 ~ 14	10	22.5
BC-PG19-G	12 ~ 16	10.3	23.8
BC-PG21-G	13 ~ 18	10	28.3
BC-PG25-G	16 ~ 21	11	30
BC-PG29-G	18 ~ 25	12	36.6
BC-PG36-G	22 ~ 32	14	46.2
BC-PG42-G	32 ~ 38	14.2	54
BC-PG48-G	37 ~ 44	15	59
BC-PG63-G	42 ~ 50	28	70.5

BC-PG-L LONG CABLE GLAND



BASE

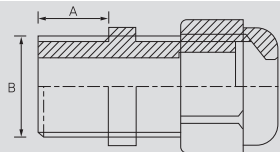

모델규격 Model and size

Article no.	Cable Range (φ mm)	A (mm)	B (mm)
BC-PG7L-G	3 ~ 6.5	15	12.5
BC-PG9L-G	4 ~ 8	15	15.2
BC-PG11L-G	5 ~ 10	15	18.5
BC-PG13.5L-G	6 ~ 12	15	20.5
BC-PG16L-G	10 ~ 14	15	22.2
BC-PG21L-G	13 ~ 18	15	28.3
BC-PG29L-G	18 ~ 25	18.3	37

제품특징 Product characteristics

- Material : Nylon plastic
- Hermetic seal : Nitrile rubber
- IP rating : IP66
- Ambient temperature : -20°C ~ 65°C
- Supply color : Grey

BC-BP-PG BEND PROOF CABLE GLAND



BASE

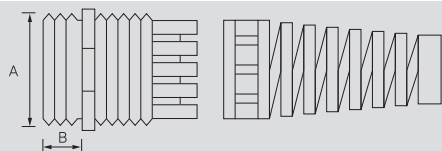

모델규격 Model and size

Article no.	Cable Range (mm)	A (mm)	B (mm)
BC-BP-PG7-G	3 ~ 6.5	8	12.5
BC-BP-PG9-G	4 ~ 8	8	15.2
BC-BP-PG11-G	5 ~ 10	9	18.6
BC-BP-PG13.5-G	6 ~ 12	9	20.6
BC-BP-PG16-G	10 ~ 14	10	22.8
BC-BP-PG21-G	13 ~ 18	10.5	28.3

제품특징 Product characteristics

- Material : Nylon plastic
- Hermetic seal : Nitrile rubber
- Ambient temperature : quiescent state -40°C to 100°C, short time to 120°C, dynamic -20°C to 80°C, short time to 100°C
- Supply color : Grey

케이블 그랜드

Cable Glands

BC-MPG METAL CABLE GLAND / BC-MPG-L METAL LONG CABLE GLAND



BASE

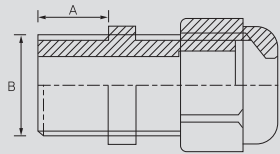

제품특징 Product characteristics

- Material : Body : nickel-plated brass Seal : Polymide 66, Sealing : NBR
- Protection degree : Within the clamping range, its protection degree can reach IP68.
- Properties : succeed in the experiment of IEC-60077-1999 resistance to vibration and impact.
- Temperature Range : Stat. :Min-40°C, Max 100°C, Short-term 120°C
Dyn. :Min-20°C, Max 80°C, Short-term 100°C

모델규격 Model and size

BC-MPG METAL CABLE GLAND

Article no.	Cable Range (φ mm)	A (mm)	B (mm)
BC-MPG7	3 ~ 6.5	6.2	12.1
BC-MPG9	4 ~ 8	6.8	14.8
BC-MPG11	5 ~ 10	7.1	18.2
BC-MPG13.5	6 ~ 12	8	20
BC-MPG16	10 ~ 14	7.5	21.9
BC-MPG19	12 ~ 15	7.5	23.6
BC-MPG21	13 ~ 18	8.4	28
BC-MPG25	16 ~ 22	8.5	29.6
BC-MPG29	18 ~ 25	9.5	36.6
BC-MPG36	22 ~ 32	10.2	47
BC-MPG42	32 ~ 38	11.5	54
BC-MPG48	37 ~ 44	11.8	59
BC-MPG63	42 ~ 52	19.2	71.2

BC-MPG-L METAL LONG CABLE GLAND

Article no.	Cable Range (φ mm)	A (mm)	B (mm)
BC-MPG7L	3 ~ 6.5	10	12.5
BC-MPG9L	4 ~ 8	10	15.2
BC-MPG11L	5 ~ 10	10	18.6
BC-MPG13.5L	6 ~ 12	10	20.4
BC-MPG16L	10 ~ 14	10	22.5
BC-MPG19L	12 ~ 15	12	23.5
BC-MPG21L	13 ~ 18	12	28.3
BC-MPG25L	16 ~ 22	12	33.5
BC-MPG29L	18 ~ 25	12	37
BC-MPG36L	22 ~ 32	12	47
BC-MPG42L	32 ~ 38	15	54
BC-MPG48L	37 ~ 44	15	59.3

BC-PKM-P PKM METAL CABLE GLAND



BASE

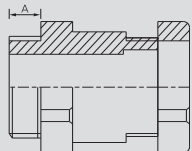

모델규격 Model and size

Article no.	Cable Range (φ mm)	A (mm)	B (mm)
BC-PKM-P7	6 ~ 8	6	15
BC-PKM-P9	8 ~ 10	7	17
BC-PKM-P11	10 ~ 12	7	20
BC-PKM-P13	12 ~ 14	7	24

제품특징 Product characteristics

- Material : Body:nickel-plated brass Sealing:NBR
- Protection degree : Within the clamping range, its protection degree can reach IP65

BC-HSK-EX-P EX PLASTIC CABLE GLAND



BASE

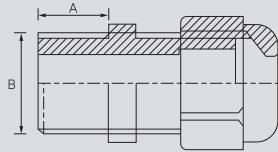

모델규격 Model and size

Article no.	Cable Range (mm)	A (mm)	B (mm)	Wrench size (mm)
BC-HSK-EX-P7	3 ~ 6.5	8	12.5	15
BC-HSK-EX-P9	4 ~ 8	8	15.2	19
BC-HSK-EX-P11	5 ~ 10	8	18.6	22
BC-HSK-EX-P13	6 ~ 12	9	20.4	24
BC-HSK-EX-P16	8 ~ 14	10	22.5	27
BC-HSK-EX-P21	13 ~ 18	11	28.3	33
BC-HSK-EX-P29	18 ~ 25	11	37	42
BC-HSK-EX-P36	22 ~ 32	13	47	53
BC-HSK-EX-P42	30 ~ 38	15	54	60
BC-HSK-EX-P48	37 ~ 44	15	59.3	65

제품특징 Product characteristics

- Material : Polyamide 66, sealing : NBR
- Color : Grey white(RAL 7035), Black (RAL 9005)
- Protection degree : Using suitable O-sealings within the clamping range, its protection degree can reach IP68
- Temperature Range : Stat.:Min-40°C, Max 100°C, Short-term 120°C
Dyn.:Min-20°C, Max 80°C, Short-term 100°C
- Properties : V2(94), free of halogen, phosphor and cadmium, passed RoHS UV-resistance, ageing-resistance certificates
- EX degree : Exe II T5 Certificate No.: CNEx07.0311U

BC-HSM-EX-P EX METAL CABLE GLAND



BASE

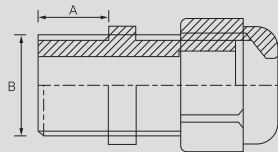

모델규격 Model and size

Article no.	Cable Range (mm)	A (mm)	B (mm)
BC-HSM-EX-P7	3 ~ 6.5	6	12.5
BC-HSM-EX-P9	4 ~ 8	7	15.2
BC-HSM-EX-P11	5 ~ 10	7	18.6
BC-HSM-EX-P13	6 ~ 12	7	20.4
BC-HSM-EX-P16	8 ~ 14	7	22.5
BC-HSM-EX-P21	13 ~ 18	7	28.3
BC-HSM-EX-P29	18 ~ 25	8	37
BC-HSM-EX-P36	22 ~ 32	9	47
BC-HSM-EX-P42	30 ~ 38	9	54
BC-HSM-EX-P48	37 ~ 44	10	59.3

제품특징 Product characteristics

- Material : Body : nickel-plated brass Seal : Polyamide 66, Sealing : NBR
- Protection degree : Within the clamping range, its protection degree can reach IP68.
- Properties : succeed in the experiment of IEC-60077-1999 resistance to vibration and impact.
- Temperature Range : Stat.:Min-40°C, Max 100°C, Short-term 120°C
Dyn.:Min-20°C, Max 80°C, Short-term 100°C
- Ex degree : Exe II T5 Certificate No : CNEx07.03126

BC-RG-PG RUBBER GROMMET PG



BASE

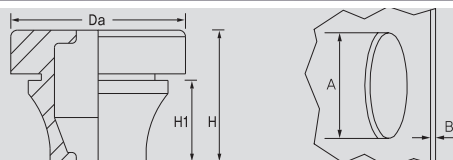

모델규격 Model and size

Article no.	Thread AD(mm)	Φ mm (cable)	타공치수 A (mm)	박스두께 B(mm)	Da (mm)	H (mm)	H1 (mm)
BC-RG-PG7	12.5	3 ~ 5	13	0.5 ~ 2	20	12.6	5.4
BC-RG-PG9	15.2	5 ~ 7	16	1 ~ 4	21	17.8	10.3
BC-RG-PG11	18.6	7 ~ 10	19	1 ~ 4	24	19.8	12.7
BC-RG-PG16	22.5	10 ~ 14	23	1 ~ 4	28	21.6	14.7
BC-RG-PG21	28.3	14 ~ 20	29	1 ~ 4	35	24.6	17.6
BC-RG-PG29	37	20 ~ 26	38	1 ~ 4	46	28.5	20
BC-RG-PG36	47	26 ~ 35	48	1 ~ 4	58	34.9	23.9

제품특징 Product characteristics

- Mode of protection : IP67 acc. to EN 60529
- Temperature range : -40°C...+100°C
- Test standard : EMKO TUI(03-SEC) F1001/84
- Semko report : 410375
- Halogen-Free

케이블 그랜드

Cable Glands

BC-SP-PG SCREW PLUG



BASE

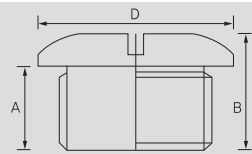

모델규격 Model and size

Article no.	A (mm)	B (mm)	D (mm)
BC-SP-PG7	8.5	12.5	12.5
BC-SP-PG9	8.5	13	15.3
BC-SP-PG11	9	13	18.4
BC-SP-PG13.5	8.5	13	20.4
BC-SP-PG16	10.5	15	22.3
BC-SP-PG21	10.5	15.5	28.3
BC-SP-PG29	11.5	16	36.6
BC-SP-PG36	13.5	18	46.2
BC-SP-PG42	13.5	18.5	54
BC-SP-PG48	14.5	19.5	59

제품특징 Product characteristics

- Material : nylon plastic
- Protection degree : IP54
- Ambient temperature : -40°C to 100°C
- Supply color : Grey, Black

BC-MSP-PG METAL SCREW PLUG

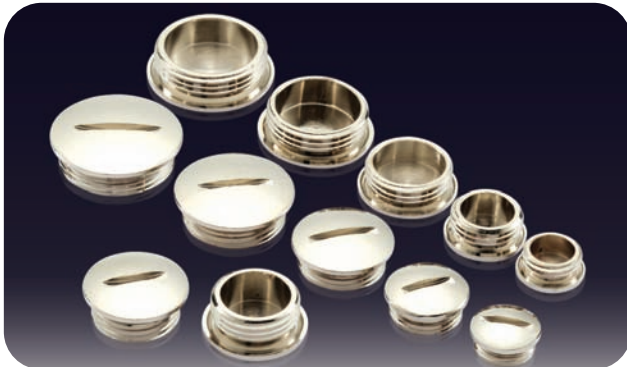

BASE

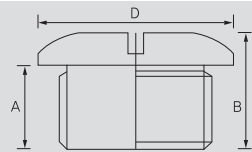

모델규격 Model and size

Article no.	A (mm)	B (mm)	Wrench size (mm)
BC-MSP-PG7	7	9.6	14
BC-MSP-PG9	7	9.7	18
BC-MSP-PG11	7	10.3	20
BC-MSP-PG13.5	8.1	11.5	22
BC-MSP-PG16	7.5	10.5	24
BC-MSP-PG21	7.8	11	30
BC-MSP-PG29	9.5	13	40
BC-MSP-PG36	8.7	14	50
BC-MSP-PG42	10	14.7	57.2
BC-MSP-PG48	10	15	64

제품특징 Product characteristics

- Material : Nickel-plated brass
- Protection degree : IP68

BC-HP-PG HOLE PLUG



BASE

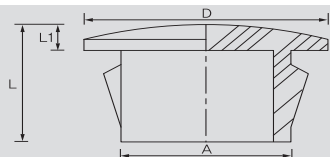

모델규격 Model and size

Article no.	A	D	L1	L
	Aperture of the steel board	OD of the plug	Thickness	Total length
BC-HP-PG8	7.8	11.9	1.6	8
BC-HP-PG10	9.5	13	1.6	10.5
BC-HP-PG13	12.7	16.9	1.6	10.5
BC-HP-PG16	15.9	19.8	1.6	10.5
BC-HP-PG19	19	22.9	1.6	10.5
BC-HP-PG22	22.2	24.9	1.6	11.5
BC-HP-PG26	25.5	28.3	1.6	11.5
BC-HP-PG30	30	34.2	1.6	11.5

제품특징 Product characteristics

- Material : PA66, 94-V2
- Color : Black(RAL 9005)
- Temperature Range : Min -40°C, Max 100°C
- Application : To cover the spare holes, by pushing the plug with your hand, you can finish the assembly easily without additional tools, suitable for the steel board below 3.2mm

BC-DPM-P HEXAGON PLUG

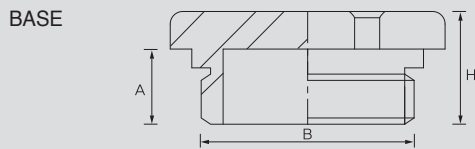

모델규격 Model and size

Article no.	A (mm)	B (mm)	B (mm)	H (mm)
BC-DPM-P7	6	12.5	15	9
BC-DPM-P9	7	15.2	18	10
BC-DPM-P11	7	18.6	21	10.5
BC-DPM-P13	7	20.4	23	10.5
BC-DPM-P16	7	22.5	26	10.5
BC-DPM-P21	7	28.3	32	11
BC-DPM-P29	8	37	40	12
BC-DPM-P36	9	47	50	14
BC-DPM-P42	9	54	58	14
BC-DPM-P48	10	59.3	65	16

제품특징 Product characteristics

- Material : Nickel-plated brass
- Protection degree : IP68

BC-M CABLE GLAND / BC-M-L LONG CABLE GLAND

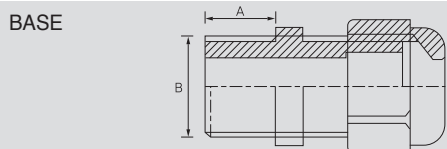

모델규격 Model and size

BC-M CABLE GLAND

Article no.	Cable Range (φ mm)	A (mm)	B (mm)
BC-M12-G	3 ~ 6.5	8	12
BC-M16-G	4 ~ 8	8	16
BC-M18-G	5 ~ 10	8	18
BC-M20-G	6 ~ 12	10	20
BC-M22-G	10 ~ 14	10	22
BC-M24-G	12 ~ 16	10	24
BC-M25-G	12 ~ 16	10	25
BC-M27-G	13 ~ 18	10	27
BC-M30-G	16 ~ 21	10	30
BC-M32-G	18 ~ 25	11	32
BC-M36-G	18 ~ 25	11.5	36
BC-M40-G	22 ~ 32	15	40
BC-M50-G	32 ~ 38	15.5	50
BC-M63-G	37 ~ 44	14.5	63

BC-M-L LONG CABLE GLAND

Article no.	Cable Range (φ mm)	A (mm)	B (mm)
BC-M12L	3 ~ 6.5	15	12
BC-M16L	4 ~ 8	15	16
BC-M18L	5 ~ 10	15	18
BC-M20L	6 ~ 12	15	20
BC-M22L	10 ~ 14	15	22
BC-M25L	12 ~ 16	15	25
BC-M32L	18 ~ 25	15	32

제품특징 Product characteristics

- Material : Nylon plastic
- Hermetic seal : Nitrile rubber
- IP rating : IP66
- Ambient temperature : -20°C ~ 65°C

케이블 그랜드

Cable Glands

BC-BP-M BEND PROOF CABLE GLAND

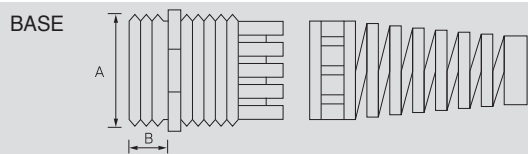

모델규격 Model and size

Article no.	Cable Range (∅ mm)	A (mm)	B (mm)
BC-BP-M12-G	3 ~ 6.5	7.5	12
BC-BP-M16-G	4 ~ 8	8	16
BC-BP-M18-G	5 ~ 10	8	18
BC-BP-M20-G	6 ~ 12	9	20
BC-BP-M22-G	10 ~ 14	10	22
BC-BP-M25-G	13 ~ 18	10.4	25

제품특징 Product characteristics

- Material : Nylon plastic
- Hermetic seal : Nitrile rubber
- Ambient temperature : quiescent state-40°C to 100°C, short time to 120°C, dynamic-20°C to 80°C, short time to 100°C
- Supply color : Grey

BC-MM METAL CABLE GLAND / BC-MM-L METAL LONG CABLE GLAND

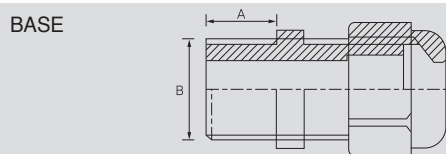

모델규격 Model and size

BC-MM METAL CABLE GLAND

Article no.	Cable Range (∅ mm)	A (mm)	B (mm)
BC-MM12	3 ~ 6.5	6	12
BC-MM16	4 ~ 8	7	16
BC-MM18	5 ~ 10	7	18
BC-MM20	6 ~ 12	8	20
BC-MM22	10 ~ 14	7.5	22
BC-MM24	12 ~ 15	7.5	24
BC-MM25	13 ~ 18	8	25
BC-MM27	13 ~ 18	8.3	27
BC-MM30	16 ~ 22	8.3	30
BC-MM32	16 ~ 22	8.3	32
BC-MM36	18 ~ 25	10	36
BC-MM40	22 ~ 32	11.2	40
BC-MM50	32 ~ 38	11.2	50
BC-MM63	37 ~ 44	12.4	63

BC-MM-L METAL LONG CABLE GLAND

Article no.	Cable Range (∅ mm)	A (mm)	B (mm)
BC-MM12L	3 ~ 6.5	10	12
BC-MM16L	4 ~ 8	10	16
BC-MM18L	5 ~ 10	10	18
BC-MM20L	6 ~ 12	10	20
BC-MM22L	10 ~ 14	10	22
BC-MM24L	12 ~ 15	10	24
BC-MM25L	13 ~ 18	12	25
BC-MM27L	13 ~ 18	12	27
BC-MM30L	16 ~ 22	12	30
BC-MM32L	16 ~ 22	12	32
BC-MM36L	18 ~ 25	15	36
BC-MM40L	22 ~ 32	15	40
BC-MM50L	32 ~ 38	15	50
BC-MM63L	37 ~ 44	15	63

제품특징 Product characteristics

- Material : Body : nickel-plated brass Seal : Polymide 66, Sealing : NBR
- Protection degree : Within the clamping range, its protection degree can reach IP68.
- Properties : succeed in the experiment of IEC-60077-1999 resistance to vibration and impact.
- Temperature Range : Stat. : Min-40°C, Max 100°C, Short-term 120°C
Dyn. : Min-20°C, Max 80°C, Short-term 100°C

BC-SP-M SCREW PLUG



BASE

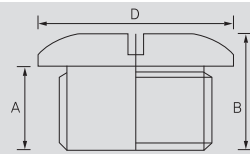

모델규격 Model and size

Article no.	A (mm)	B (mm)	D (mm)
BC-SP-M-12	7	9.7	14
BC-SP-M-16	6.3	9	18
BC-SP-M-18	6.7	10	20
BC-SP-M-20	8	11.5	22
BC-SP-M-22	7	10.5	24
BC-SP-M-25	9	11.3	27
BC-SP-M-27	7.5	10.2	32
BC-SP-M-32	7.5	10.7	34
BC-SP-M-40	8	12.5	42
BC-SP-M-50	10	14	52
BC-SP-M-63	10.5	15	67

제품특징 Product characteristics

- Material : nylon plastic
- Protection degree : IP54
- Ambient temperature : -40°C to 100°C
- Supply color : Grey, Black

BC-MSP-M METAL SCREW PLUG

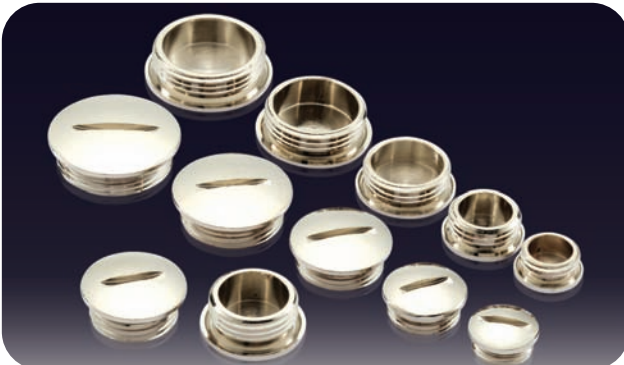

BASE

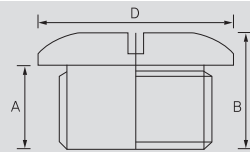

모델규격 Model and size

Article no.	A (mm)	B (mm)	Wrench size (mm)
BC-MSP-M12	7	9.7	14
BC-MSP-M16	6.3	9	18
BC-MSP-M18	6.5	10	19.8
BC-MSP-M20	7	10.3	22
BC-MSP-M22	7	10.5	24
BC-MSP-M25	8	11.7	27
BC-MSP-M32	7.5	10.7	34
BC-MSP-M40	8	13	42
BC-MSP-M50	10.3	14.5	52.2
BC-MSP-M63	10.5	15	67

제품특징 Product characteristics

- Material : Nickel-plated brass
- Protection degree : IP68



액세서리

Accessories

BC-V60, V80 VENT

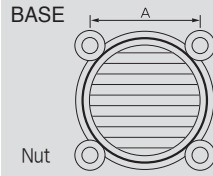

모델규격 Model and size

Article no.	A	가공치수 Processing Size	환기팬 치수 Ventilation Fan Size
BC - V 60	50 ±0.3mm	63 ~ 65 ∅	60 ∅
BC - V 80	71.5±0.3mm	88 ~ 90 ∅	80 ∅

제품특징 Product characteristics

1. 박스내부의 발열을 외부로 쉽게 배출하게 해주는 부품입니다.
2. 내부에 냉각팬이 쉽게 설치하게 되어 있습니다.
3. 강우시 빗물이 쉽게 내부로 들어오지 못하게 처리되어 있습니다.

Draw latch

- Material : SUS 304
- BC-L75 • BC-L65 • BC-L55



BC - L75



BC - L65



BC - L55

Wall mounting bracket

- Material : SUS 304
- BC-B60 • BC-B50 • BC-B40



BC - B60



BC - B50



BC - B40

Integral latch

- Material : SUS 304, Plastic
- Use for P series



BC - PSK50



BC - PSK35



BC - PSK20

Plastic Bracket

- Material : PC
- PB50 • PB40



PB50



PB40

Hinge

- Material : SUS 304
- BC-H75 • BC-H65 • BC-H55



BC - H75



BC - H65



BC - H55

Duct Ring

- Material : Steel(Zinc plating-아연도금)



BC - D30L



BC - D30S



BC - D25L



BC - D25S

Dual door

- Material : ABS
- 테, 지지대, 힌지, 손잡이 포함
Including frame, pillar, hinge, handle



Earth Stud

- Material : SUS 304
- BC-ES
- 플라스틱박스용 접지볼트



BC-ES

Plastic lock

- Material : Nylon
- 적용대상 - 힌지형 전제품 :
Available for all hinge type enclosure



BC - PK

Lock

- Material : SUS 304 etc.
- 적용대상 - 힌지형 전제품 :
Available for all hinge type enclosure



BC - SK

Key Ring

- Material : SUS 304
- 적용대상 - 힌지형 전제품 :
Available for all hinge type enclosure



BC - K40

Cover Bolt

- Material : ABS



CB20- CB20 CB28- CB28 CB35 CB50

Dual door mounting plate

- Material : Aluminium
- 플라스틱 중 · 대형 엔클로저
Medium and large plastic enclosure



Plastic mounting plate

- Material : ABS
- 플라스틱 전제품 All of plastic enclosure

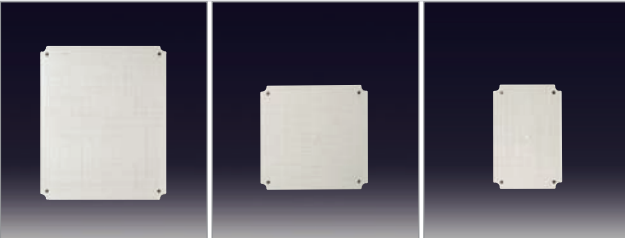

Steel mounting plate

- Material : Steel(Zinc plating-아연도금)
- 플라스틱 엔클로저, 알루미늄 엔클로저 전제품
All of plastic and aluminium enclosure

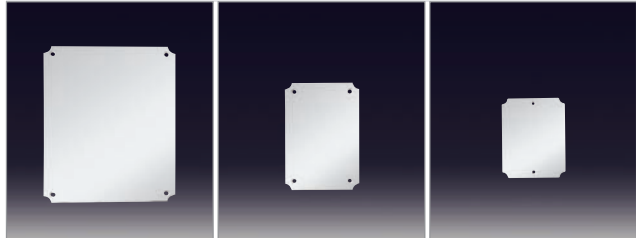

주식회사 **박스코**

본사 및 공장 부산광역시 사하구 신산로 134

T. 051-313-4401~7 F. 051-313-4408

부산전시판매장 부산광역시 사상구 광장로 20번길 62(산업용품유통단지 서문앞)

T. 051-902-4401 F. 051-902-4408

구로전시판매장 서울특별시 구로구 경인로 53길 15 중앙유통단지 나동 1515호

T. 02-2612-4401 F. 02-2612-4407

안양전시판매장 경기도 안양시 동안구 엘에스로92 안양국제유통단지 17동 108호

T. 031-451-4401 F. 031-451-4408

BOXCO Inc.

Head office and factory : 134, Sinsan-ro, Saha-gu, Busan, 49438, Korea

本社 · 工厂 : 釜山广域市沙下区新山路 134

T. +82-51-3134407 F. +82-51-3164408

上海比夕电气有限公司

上海市松江区申港路215号503室

T. 021-64130961/64130962-806 F. 021-54293895

www.boxco.kr www.boxco.eu www.boxco.cn

E-mail : info@boxco.kr

※제품관련 문의는 본사로 연락바랍니다.

If you have any questions about our products, please call head office.